

SURFACES
FOR
ARCHI
TECTURE
 AND
INTERIORS



COLLECTIONS

25



About us

- Style
- Group
- Technology
- 6mm
- Collections

Interiors

MARBLE

- La Marmoteca

STONE

- La Geoteca
- Pietra Viva
- Origini
- Concept Stone
- Burlington Stone

RESIN

- I Pigmenti

SOLID COLORS

- Chrome

METAL

- Oxide

CONCRETE

- Make

WOOD

- Just Code
- Just Nature
- Just Color

Decor

- Boiserie
- Gioia

Technical Info

- Technical info

Outdoor

STONE

- La Geoteca
- Pietra Viva
- Origini
- Fusion

- Burlington Stone

- Concept Stone

- Antiqua

- Soul

- Suisse

RESIN

- I Pigmenti

METAL

- Oxide

CONCRETE

- Make

- Native

- Mesh Up

WOOD

- Just Code

- Timber

- Woodland

INDEX

Gardenia Orchidea riscrive i codici dell'eleganza in chiave contemporanea

La ricerca del bello che da sempre identifica il brand, ritrova slancio grazie al perfetto connubio tra ricerca stilistica e innovazione tecnica. I prodotti Gardenia Orchidea, sempre più rivolti ai diversi ambiti della progettazione, si fanno ancora una volta portavoce di eleganza ed esclusività, ma con un tocco più contemporaneo, per trasferire una nuova idea di lusso sia nei contesti residenziali, che negli spazi condivisi.

Gardenia Orchidea rewrites the rules of elegance in a contemporary style. The quest for beauty, which has always identified this brand, takes a major step forward thanks to a perfect combination of style research and technical innovation. Gardenia Orchidea products, always an ambassador for elegance and exclusivity with a contemporary touch, are increasingly targeting different areas of design to transmit a new idea of luxury to both residential contexts and shared spaces.



STI LE GAR DE NIA

About us

- Style
- Group
- Technology
- 6mm
- Collections

Interiors

- MARBLE**
- La Marmoteca
- STONE**
- La Geoteca
- Pietra Viva
- Origini
- Concept Stone
- Burlington Stone
- RESIN**
- I Pigmenti
- SOLID COLORS**
- Chrome
- METAL**
- Oxide
- CONCRETE**
- Make
- WOOD**
- Just Code
- Just Nature
- Just Color

Decor

- Boiserie
- Gioia

Technical Info

Technical info

Outdoor

- STONE**
- La Geoteca
- Pietra Viva
- Origini
- Fusion
- Burlington Stone
- Concept Stone
- Antiqua
- Soul
- Suisse
- RESIN**
- I Pigmenti
- METAL**
- Oxide
- CONCRETE**
- Make
- Native
- Mesh Up
- WOOD**
- Just Code
- Timber
- Woodland

INDEX

MOLTO PIÙ DI UN BRAND



OUR NUMBERS



More than
13+ mln sqm
PRODUCTION
CAPACITY



More than
7,0+ mln sqm
WAREHOUSE
CAPACITY



More than
200.000+ sqm
BUILDING AREA



More than
800+
EMPLOYEES



More than
7.000+
WORLDWIDE
CUSTOMERS



120
COUNTRIES
SERVED

OUR LOCATIONS



Fiorano (MO)
Headquarters



Solignano (MO)
Big sizes and Slabs
7,5 mln sqm production capacity



Finale Emilia (MO)
Traditional sizes and decor
1,5 mln sqm production capacity



Fiorano (MO)
Logistic Warehouse



Louvroil (Francia)
Traditional sizes and outdoor 20mm
4,0 mln sqm production capacity

Dietro alla forza di Gardenia Orchidea c'è la storia e il know how di uno dei top player del settore ceramico italiano, oggi multinazionale: capacità produttiva, ricerca stilistica e versatilità applicativa per il mondo del design e l'architettura.

ABK GROUP vanta oggi una capacità produttiva di 13 milioni di mq al servizio di diversi marchi commerciali. Gardenia Orchidea offre una gamma di prodotti d'eccellenza, diversificata per soddisfare ogni necessità in fatto di pavimenti e rivestimenti, compresi i prodotti outdoor e le grandi lastre.

Much more than a brand. Building on its long history as one of the top players in the Italian ceramic tile industry, Gardenia Orchidea recently became a multinational with the acquisition of a historic French brand. Alongside the existing facilities located in the Modena area.

Today ABK GROUP reaches a production capacity of 13 million square meters serving different brands. Gardenia Orchidea offers a wide range of high-quality products suitable for all floor and wall applications, including outdoor products and large slabs.

About us

Style
Group
Technology
6mm
Collections

Interiors

MARBLE
La Marmoteca

STONE
La Geoteca
Pietra Viva
Origini
Concept Stone
Burlington Stone

RESIN
I Pigmenti

SOLID COLORS
Chrome

METAL
Oxide

CONCRETE
Make

WOOD
Just Code
Just Nature
Just Color

Decor

Boiserie
Gioia

Technical Info

Technical info

Outdoor

STONE
La Geoteca
Pietra Viva
Origini
Fusion

Burlington Stone
Concept Stone

Antiqua
Soul
Suisse

RESIN
I Pigmenti

METAL
Oxide

CONCRETE
Make

Native
Mesh Up

WOOD
Just Code

Timber
Woodland

INDEX

INNOVAZIONE

3D tech

La tecnologia 3D Tech consente di applicare differenti materie ceramiche, anche a spessore, in perfetta corrispondenza con la grafica sottostante, realizzata in digitale ad altissima definizione. Un processo produttivo rivoluzionario, che combina la matericità con l'estetica del prodotto, fino ad ottenere superfici dallo straordinario valore sensoriale.

The new 3D Tech technology allows thick layers of various ceramic materials to be applied in perfect alignment with the underlying graphic designs, which are created digitally with extremely high definition. This revolutionary production process combines material and aesthetic effects to create surfaces with extraordinary sensorial appeal.



ANTIQUÉ 3D

La finitura Antique 3D richiama il fascino dei marmi consumati dal tempo, unendo eleganza classica e autenticità. Caratterizzata da un corpo leggermente strutturato, combina rilievi delicati e texture materiche per creare superfici dall'aspetto vissuto, ideali per donare agli spazi un carattere unico e un design ricco di personalità.

The Antique 3D finish is reminiscent of the charm of timeworn marbles, combining classic elegance and authenticity. Characterised by a slightly structured body, it combines delicate embossing and material textures to create surfaces with a lived-in look, ideal for giving spaces unique character and a design rich in personality.

LUX 3D

La finitura Lux 3D si caratterizza per il suo effetto lucido e brillante, pur mantenendo dettagli in bassorilievo per un effetto visivo sofisticato e ricercato. Ideale per ambienti moderni ed eleganti, dona un senso di spaziosità e luminosità grazie al riflesso della luce sulle superfici.

The Lux 3D finish is characterised by its glossy and luminous effect, while maintaining bas-relief details making it visually sophisticated and refined. Ideal for modern and elegant settings, it bestows a sense of space and luminosity thanks to the light reflecting on the surfaces.

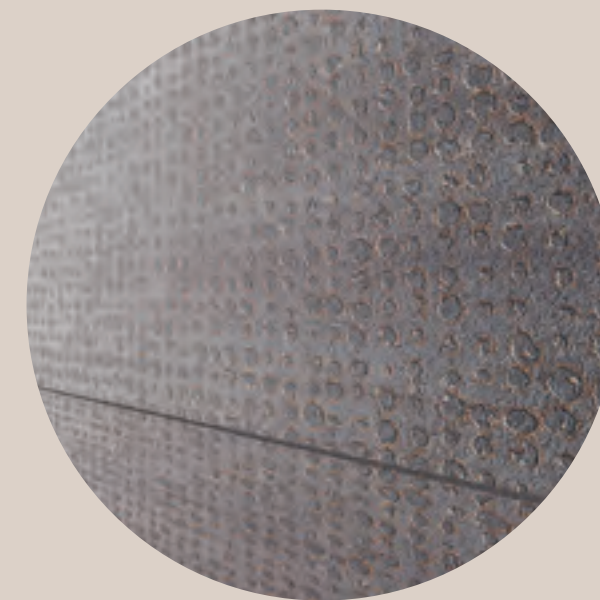

DECORATIONS NAT 3D

Le superfici tridimensionali Nat 3D offrono un effetto naturale e autentico, grazie a texture che richiamano materiali grezzi. Questa finitura è ideale per chi desidera creare ambienti dallo stile essenziale e contemporaneo, aggiungendo un tocco di carattere che valorizza ogni spazio.

Nat 3D three-dimensional surfaces feature a natural and authentic effect, thanks to textures that evoke raw materials. This finish is perfect for anyone who wants to create spaces with a minimalist and contemporary vibe, adding a touch of character that can enhance any and every space.



DECORATIONS LUX 3D

About us

- Style
- Group
- Technology
- 6mm
- Collections

Interiors

MARBLE

La Marmoteca

STONE

La Geoteca

Pietra Viva

Origini

Concept Stone

Burlington Stone

RESIN

I Pigmenti

SOLID COLORS

Chrome

METAL

Oxide

CONCRETE

Make

WOOD

Just Code

Just Nature

Just Color

Decor

Boiserie

Gioia

Technical Info

Technical info

Outdoor

STONE

La Geoteca

Pietra Viva

Origini

Fusion

Burlington Stone

Concept Stone

Antiqua

Soul

Suisse

RESIN

I Pigmenti

METAL

Oxide

CONCRETE

Make

Native

Mesh Up

WOOD

Just Code

Timber

Woodland

INDEX

INNOVAZIONE

SOFT 3D

La tecnologia SOFT3D consente di realizzare lastre dalla finitura extra morbida arricchite da effetti di bassorilievo che ne esaltano la naturalezza. La differente densità delle materie utilizzate in superficie, nelle zone selezionate, ricrea chimicamente le profondità, che si sovrappongono in maniera esatta alla grafica digitale ad alta risoluzione.

The SOFT3D technology allows to create slabs with an extra smooth finish, enriched with bas-relief effects that enhance the naturalness of the surface. The different density of the raw materials applied in the selected areas, chemically recreates the depths that exactly match the high-resolution digital graphic.



P. tech

La tecnologia P.TECH migliora la resistenza allo scivolamento, pur mantenendo una piacevole sensazione al tatto. P.TECH è il risultato di un innovativo processo produttivo che coniuga la selezione delle materie prime con le fasi di pressatura, cottura e lavorazione a fine linea. I prodotti P.TECH, pur raggiungendo i più elevati coefficienti di attrito, si puliscono facilmente, per questo possono essere utilizzati nei progetti wellness e outdoor, anche in aree pubbliche o commerciali.

The unique P.TECH technology improves slip resistance while maintaining a pleasant tactile sensation. P.TECH is the result of an innovative production process that combines a meticulous selection of raw materials with the pressing, firing and end-of-line processing stages. Despite their high coefficient of friction, P.TECH products are easy to clean, making them ideal not only for use on indoor floors but also in wellness and outdoor spaces in public or commercial areas.

About us

- Style
- Group
- Technology
- 6mm
- Collections

Interiors

MARBLE

La Marmoteca

STONE

La Geoteca

Pietra Viva

Origini

Concept Stone

Burlington Stone

RESIN

I Pigmenti

SOLID COLORS

Chrome

METAL

Oxide

CONCRETE

Make

WOOD

Just Code

Just Nature

Just Color

Decor

Boiserie

Gioia

Technical Info

Technical info

Outdoor

STONE

La Geoteca

Pietra Viva

Origini

Fusion

Burlington Stone

Concept Stone

Antiqua

Soul

Suisse

RESIN

I Pigmenti

METAL

Oxide

CONCRETE

Make

Native

Mesh Up

WOOD

Just Code

Timber

Woodland

INDEX

6MM

La ceramica va per il sottile

Le piastrelle a 6mm di spessore offrono un'installazione più pratica e veloce grazie alla loro leggerezza e maneggevolezza. Lo spessore ridotto mantiene intatta la resistenza e la versatilità delle superfici in gres, riducendone l'impatto ambientale.

Our 6mm thick tiles are light and easy to handle and therefore quicker and more practical to install. Their reduced thickness maintains all the strength and versatility of porcelain stoneware surfaces while lowering their environmental impact.

DISPONIBILE IN: | AVAILABLE IN:

La Marmoteca P. 18
La Geoteca P. 44



- Sottile e resistente**
THIN AND DURABLE
- Risparmio energetico**
ENERGY SAVING
- Basse emissioni**
LOW CO2 EMISSIONS
- Posa più veloce**
QUICKER INSTALLATION
- Facile da tagliare**
EASY TO CUT
- Ideale per le ristrutturazioni**
IDEAL FOR RENOVATIONS

About us

Style
Group
Technology
6mm
Collections

Interiors

MARBLE
La Marmoteca

STONE
La Geoteca
Pietra Viva
Origini
Concept Stone
Burlington Stone

RESIN
I Pigmenti

SOLID COLORS
Chrome

METAL
Oxide

CONCRETE
Make

WOOD
Just Code
Just Nature
Just Color

Decor

Boiserie
Gioia

Technical Info

Technical info

Outdoor

STONE
La Geoteca
Pietra Viva
Origini
Fusion
Burlington Stone
Concept Stone
Antiqua
Soul
Suisse

RESIN
I Pigmenti

METAL
Oxide

CONCRETE
Make
Native
Mesh Up

WOOD
Just Code
Timber
Woodland

INDEX

INDEX

About us

- 2 Style
- 4 Group
- 6 Technology
- 10 6mm
- 14 Collections

Info

TECHNICAL INFO
216

Interiors

MARBLE

- 18 La Marmoteca

STONE

- 44 La Geoteca
- 68 Pietra Viva
- 76 Origini
- 84 Concept Stone
- 94 Burlington Stone

RESIN

- 100 I Pigmenti

SOLID COLORS

- 120 Chrome

METAL

- 124 Oxide

CONCRETE

- 136 Make

WOOD

- 144 Just Code
- 152 Just Nature
- 160 Just Color

Decor

- 168 Boiserie
- 174 Gioia

Outdoor

STONE

- 190 La Geoteca
- 191 Pietra Viva
- 193 Origini
- 193 Fusion
- 194 Burlington Stone
- 194 Concept Stone
- 195 Antiqua
- 195 Soul
- 195 Suisse

RESIN

- 196 I Pigmenti

METAL

- 199 Oxide

CONCRETE

- 199 Make
- 200 Native
- 200 Mesh up

WOOD

- 203 Just Code
- 205 Timber
- 205 Woodland

Alphabetical

- 195 Antiqua
- 168 Boiserie
- 94 194 Burlington Stone
- 84 194 Concept Stone
- 120 Chrome
- 193 Fusion
- 174 Gioia
- 144 203 Just Code
- 160 Just Color
- 152 Just Nature
- 44 190 La Geoteca
- 18 La Marmoteca
- 136 199 Make
- 200 Mesh up
- 200 Native
- 76 193 Origini
- 124 199 Oxide
- 100 196 I Pigmenti
- 68 191 Pietra Viva
- 195 Suisse
- 195 Soul
- 205 Timber
- 205 Woodland

About us

- Style
- Group
- Technology
- 6mm
- Collections

Interiors

MARBLE

- La Marmoteca

STONE

- La Geoteca
- Pietra Viva
- Origini
- Concept Stone
- Burlington Stone

RESIN

- I Pigmenti

SOLID COLORS

- Chrome

METAL

- Oxide

CONCRETE

- Make

WOOD

- Just Code
- Just Nature
- Just Color

Decor

- Boiserie
- Gioia

Technical Info

Technical info

Outdoor

STONE

- La Geoteca
- Pietra Viva
- Origini
- Fusion
- Burlington Stone

CONCRETE

- Concept Stone

Antiqua

- Soul

- Suisse

RESIN

- I Pigmenti

METAL

- Oxide

CONCRETE

- Make

- Native

- Mesh Up

WOOD

- Just Code

- Timber

- Woodland

INDEX

MARBLE

pag 18

LA MARMOTECA

120x280
120x120
60x120

6/8,5mm



Golden Carbon Deep Green Sahara Noir



Marquinia Black Grey Stone



Sahara White Calacatta Elegance Statuario Spider



Frozen Pure Onyx Statuario Premium

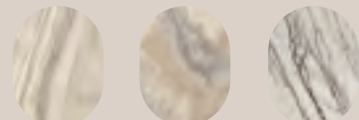

Onyx Flow Cosmic Ivory Pearl Deluxe

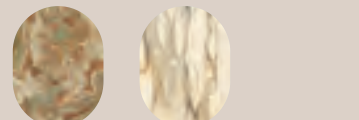

Onyx Bronze Antique Brown



Dreaming Rosè Grey Wonder



Emerald Quartz Patagonia Emerald Verde Picasso



Blue Denim

STONE

pag 44

LA GEOTECA

120x280
120x120
60x120
80x80

6/8,5/20mm



Cardoso



Provence



Serena



Limestone

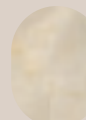

Marfil



Travertino Greige



Negresco



Ceppo di Gre



Burgougne Silver



Travertino Ivory Cross



Travertino Ivory Vein

pag 68

PIETRA VIVA

120x280
120x120
60x120
80x80

6/8,5/20mm



Antracite



Grey



Beige

pag 76

ORIGINI

100x100
80x80
60x120
60x60
30x60

8,5/20mm



Gris Royal



Crux Grey



Bolgheri

pag 84

CONCEPT STONE

80x80
40x80

8,5/20mm



Nero



Antracite



Grigio



Bianco

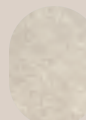

Beige Chiaro



Sabbia



Bruno Medio

pag 94

BURLINGTON STONE

80x180
80x80
100x100
60x120
60x60

8,5/20mm



Graphite



Rock



Pearl



Cream

RESIN

pag 100

I PIGMENTI

120x280
120x120
60x120
60x60
10x60
5x120
20x120
30x30

6/8,5/20mm



Concrete



Sand



Milk



Cream



Mou



Cotto



Mud



Ash



White



Clay



Bark



Steel

SOLID COLORS

pag 120

CHROME

120x280
120x120
60x120

6/8,5mm



Black

METAL

pag 124

OXIDE

120x280
120x120
60x120
80x80

6/8,5/20mm



Iron



Aluminium



Brass



Green



Steel

CONCRETE

pag 136

MAKE

100x100
80x80
40x80
60x120
60x60
30x60

8,5/20mm



Nero Corten

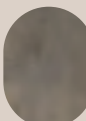

Antracite Corten



Grigio Corten



Bianco



Corda



Ash



Beige



Beige Scuro



Noce Scuro

WOOD

pag 144

JUST CODE

20x120
30x120
26,5x180

8,5/20mm



White



Miele



Rovere



Beige

pag 152

JUST NATURE

20x120
30x120

8,5mm



Greige



Sbiancato



Beige Chiaro



Beige Medio



Beige Scuro



Noce Scuro

pag 160

JUST COLOR

20x120

8,5mm



Blue

GRES PORCELLANATO
PORCELAIN TILES

About us

Style

Group

Technology

6mm

Collections

Interiors

MARBLE

La Marmoteca

STONE

La Geoteca

Pietra Viva

Origini

Concept Stone

Burlington Stone

RESIN

I Pigmenti

SOLID COLORS

Chrome

METAL

Oxide

CONCRETE

Make

WOOD

Just Code

Just Nature

Just Color

Decor

Boiserie

Gioia

Technical Info

Technical info

Outdoor

STONE

La Geoteca

Pietra Viva

Origini

Fusion

Burlington Stone

Concept Stone

Antiqua

Soul

Suisse

RESIN

I Pigmenti

METAL

Oxide

CONCRETE

Make

Native

Mesh Up

WOOD

Just Code

Timber

Woodland

INDEX

INTERIORS

MARBLE

18 La Marmoteca

STONE

44 La Geoteca
68 Pietra Viva
76 Origini
84 Concept Stone
94 Burlington Stone

RESIN

100 I Pigmenti

SOLID COLORS

120 Chrome

METAL

124 Oxide

CONCRETE

136 Make

WOOD

144 Just Code
152 Just Nature
160 Just Color



About us

Style
Group
Technology
6mm
Collections

Interiors

MARBLE

La Marmoteca

STONE

La Geoteca
Pietra Viva
Origini
Concept Stone
Burlington Stone

RESIN

I Pigmenti

SOLID COLORS

Chrome

METAL

Oxide

CONCRETE

Make

WOOD

Just Code
Just Nature
Just Color

Decor

Boiserie
Gioia

Technical Info

Technical info

Outdoor

STONE

La Geoteca
Pietra Viva
Origini
Fusion
Burlington Stone
Concept Stone
Antiqua
Soul
Suisse

RESIN

I Pigmenti

METAL

Oxide

CONCRETE

Make
Native
Mesh Up

WOOD

Just Code
Timber
Woodland

INDEX

La Marmoteca

GRES FINE PORCELLANATO
FINE PORCELAIN STONEWARE



5 SUPERFICI . SURFACES

- Soft
- Soft 3d
- Lux
- Lux 3d
- Natural Ptech



3 FORMATI . SIZES

- 120X280 . 48"X110"
- 120X120 . 48"X48"
- 60X120 . 24"X48"



2 SPESSORI . THICKNESSES

- 6MM - 8,5MM



TECNOLOGIA . TECHNOLOGY

- 3D tech**
- SOFT 3D**
- P. tech**



Frozen



Pure Onyx



Sahara White



Calacatta Elegance

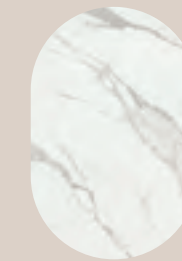

Statuario Premium



Statuario Spider



Grey Wonder



Pearl Deluxe



Onyx Flow



Cosmic Ivory



Antique Brown



Onyx Bronze



Dreaming Rosé

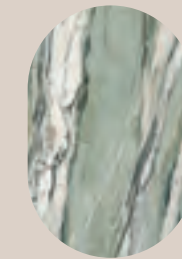

Verde Picasso



Patagonia Emerald



Emerald Quartz

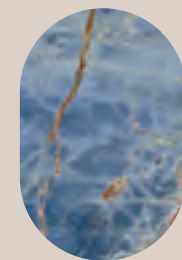

Blue Denim



Grey Stone

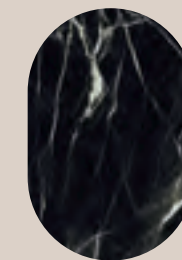

Deep Green

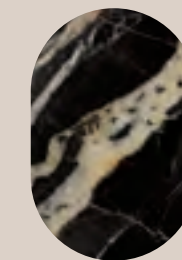

Golden Carbon

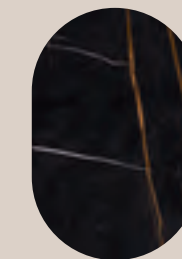

Sahara Noir



Marquinia Black

About us

- Style
- Group
- Technology
- 6mm
- Collections

Outdoor

- STONE**
- La Geoteca
- Pietra Viva
- Origini
- Fusion
- Burlington Stone
- Concept Stone
- Antiqua
- Soul
- Suisse

Interiors

- MARBLE**
- La Marmoteca

- STONE**
- La Geoteca
- Pietra Viva
- Origini
- Concept Stone
- Burlington Stone

- RESIN**
- I Pigmenti

- SOLID COLORS**
- Chrome

- METAL**
- Oxide

- CONCRETE**
- Make

- WOOD**
- Just Code
- Just Nature
- Just Color

- RESIN**
- I Pigmenti

- METAL**
- Oxide

- CONCRETE**
- Make

- Native
- Mesh Up

- WOOD**
- Just Code

- Timber
- Woodland

Decor

- Boiserie
- Gioia

Technical Info

Technical info

INDEX



Complete collection



Best box gallery



About us

- Style
- Group
- Technology
- 6mm
- Collections

Outdoor

- STONE**
- La Geoteca
- Pietra Viva
- Origini
- Fusion
- Burlington Stone
- Concept Stone
- Antiqua
- Soul
- Suisse

Interiors

- MARBLE**
- La Marmoteca
- STONE**
- La Geoteca
- Pietra Viva
- Origini
- Concept Stone
- Burlington Stone

RESIN

METAL

CONCRETE

- I Pigmenti
- SOLID COLORS**
- Chrome
- METAL**
- Oxide
- CONCRETE**
- Make
- WOOD**
- Just Code
- Just Nature
- Just Color

METAL

CONCRETE

WOOD

Decor

- Boiserie
- Gioia

Technical Info

Technical info

INDEX

Floor
Pietra Viva Beige 120x120

Furniture
Verde Picasso 120x280 Antique 3d
Pure Onyx 120x280 Lux

La Marmoteca

INTERIORS MARBLE



Floor
Cosmic Ivory 120x120 Lux



Wall Onyx Bronze 120x280 lux **Furniture** Sahara White Soft **Floor** Just Code Beige 20x120

About us

- Style
- Group
- Technology
- 6mm
- Collections

Interiors

MARBLE

La Marmoteca

STONE

- La Geoteca
- Pietra Viva
- Origini
- Concept Stone
- Burlington Stone

RESIN

I Pigmenti

SOLID COLORS

Chrome

METAL

Oxide

CONCRETE

Make

WOOD

- Just Code
- Just Nature
- Just Color

Decor

- Boiserie
- Gioia

Technical Info

Technical info

Outdoor

STONE

- La Geoteca
- Pietra Viva
- Origini
- Fusion
- Burlington Stone
- Concept Stone

Antiqua

- Soul
- Suisse

RESIN

I Pigmenti

METAL

Oxide

CONCRETE

- Make
- Native
- Mesh Up

WOOD

- Just Code
- Timber
- Woodland

INDEX



About us

- Style
- Group
- Technology
- 6mm
- Collections

Interiors

- MARBLE**
- La Marmoteca
- STONE**
- La Geoteca
- Pietra Viva
- Origini
- Concept Stone
- Burlington Stone
- RESIN**
- I Pigmenti
- SOLID COLORS**
- Chrome
- METAL**
- Oxide
- CONCRETE**
- Make
- WOOD**
- Just Code
- Just Nature
- Just Color

Decor

- Boiserie
- Gioia

Technical Info

Technical info

Outdoor

- STONE**
- La Geoteca
- Pietra Viva
- Origini
- Fusion
- Burlington Stone
- Concept Stone
- Antiqua
- Soul
- Suisse
- RESIN**
- I Pigmenti
- METAL**
- Oxide
- CONCRETE**
- Make
- Native
- Mesh Up
- WOOD**
- Just Code
- Timber
- Woodland

INDEX

Floor
I Pigmenti Clay 120x120

Furniture
Statuario Spider 120x280 Soft
Frozen 120x280 Lux

Wall
Statuario Spider 120x280 Soft

La Marmoteca

INTERIORS MARBLE



Floor
Blue Denim 120x120 Lux



Wall
Dreaming Rosè 120x280 Lux

Floor
Oxide Brass 120x120

About us

Style
Group
Technology
6mm
Collections

Interiors

MARBLE
La Marmoteca

STONE
La Geoteca
Pietra Viva
Origini
Concept Stone
Burlington Stone

RESIN
I Pigmenti

SOLID COLORS
Chrome

METAL
Oxide

CONCRETE
Make

WOOD
Just Code
Just Nature
Just Color

Decor

Boiserie
Gioia

Technical Info

Technical info

Outdoor

STONE
La Geoteca
Pietra Viva
Origini
Fusion

Burlington Stone
Concept Stone
Antiqua
Soul
Suisse

RESIN
I Pigmenti

METAL
Oxide

CONCRETE
Make
Native
Mesh Up

WOOD
Just Code
Timber
Woodland

INDEX



About us

- Style
- Group
- Technology
- 6mm
- Collections

Interiors

- MARBLE**
- La Marmoteca
- STONE**
- La Geoteca
- Pietra Viva
- Origini
- Concept Stone
- Burlington Stone

RESIN

- I Pigmenti

SOLID COLORS

- Chrome

METAL

- Oxide

CONCRETE

- Make

WOOD

- Just Code
- Just Nature
- Just Color

Decor

- Boiserie
- Gioia

Technical Info

Technical info

Outdoor

STONE

- La Geoteca
- Pietra Viva
- Origini
- Fusion

- Burlington Stone
- Concept Stone

Antiqua

- Soul
- Suisse

RESIN

- I Pigmenti

METAL

- Oxide

CONCRETE

- Make

Native

- Mesh Up

WOOD

- Just Code
- Timber
- Woodland

INDEX

Floor
Grey Wonder 120x120 Soft 3D

Furniture
Gardenia Slabs Grey Wonder 163,5x323 Soft 3D

La Marmoteca

INTERIORS MARBLE



VERDE PICASSO



GREY WONDER

A

B



PURE ONYX



FROZEN

	120x280 SOFT	120x120 SOFT	60x120 SOFT	120x280 SOFT3D	120x120 SOFT3D	60x120 SOFT3D	120x280 LUX3D	120x280 LUX3D FACE A	120x280 LUX3D FACE B	120x120 LUX3D	60x120 LUX3D
VERDE PICASSO	0014456	0014466	0014474				0014674			0014676	0014680
GREY WONDER				0014616	0014678	0014679	0014675	0014686	0014687	0014677	0014681
PRICE LIST €	F 97,90	F 83,50	F 60,50	F 97,90	F 87,90	F 63,90	F 139,9	F 139,9	F 139,9	F 118,9	F 88,50

	120x280 SOFT 6MM	120x120 SOFT 6MM	60x120 SOFT 6MM	120x280 LUX 6MM	120x120 LUX 6MM	60x120 LUX 6MM	120x120 LUX 8,5MM	60x120 LUX 8,5MM	120x120 NAT PTECH R10C 8,5MM	60x120 NAT PTECH R10C 8,5MM
PURE ONYX	0014457	0014467	0014475	0014454	0014464	0014472	0017772	0017776		
FROZEN	0014711	0014712	0014713	0014453	0014463	0014471	0017771	0017775	60017780	60017782
PRICE LIST €	F 97,90	F 83,50	F 60,50	F 124,50	F 108,90	F 78,90	F 124,50	F 78,90	F 124,50	F 78,90

About us

Style
Group
Technology
6mm
Collections

Interiors

MARBLE
La Marmoteca

STONE
La Geoteca
Pietra Viva
Origini
Concept Stone
Burlington Stone

RESIN
I Pigmenti

SOLID COLORS
Chrome

METAL
Oxide

CONCRETE
Make

WOOD
Just Code
Just Nature
Just Color

Decor

Boiserie
Gioia

Technical Info

Technical info

Outdoor

STONE
La Geoteca
Pietra Viva
Origini
Fusion
Burlington Stone
Concept Stone
Antiqua
Soul
Suisse

RESIN
I Pigmenti

METAL
Oxide

CONCRETE
Make
Native
Mesh Up

WOOD
Just Code
Timber
Woodland

INDEX

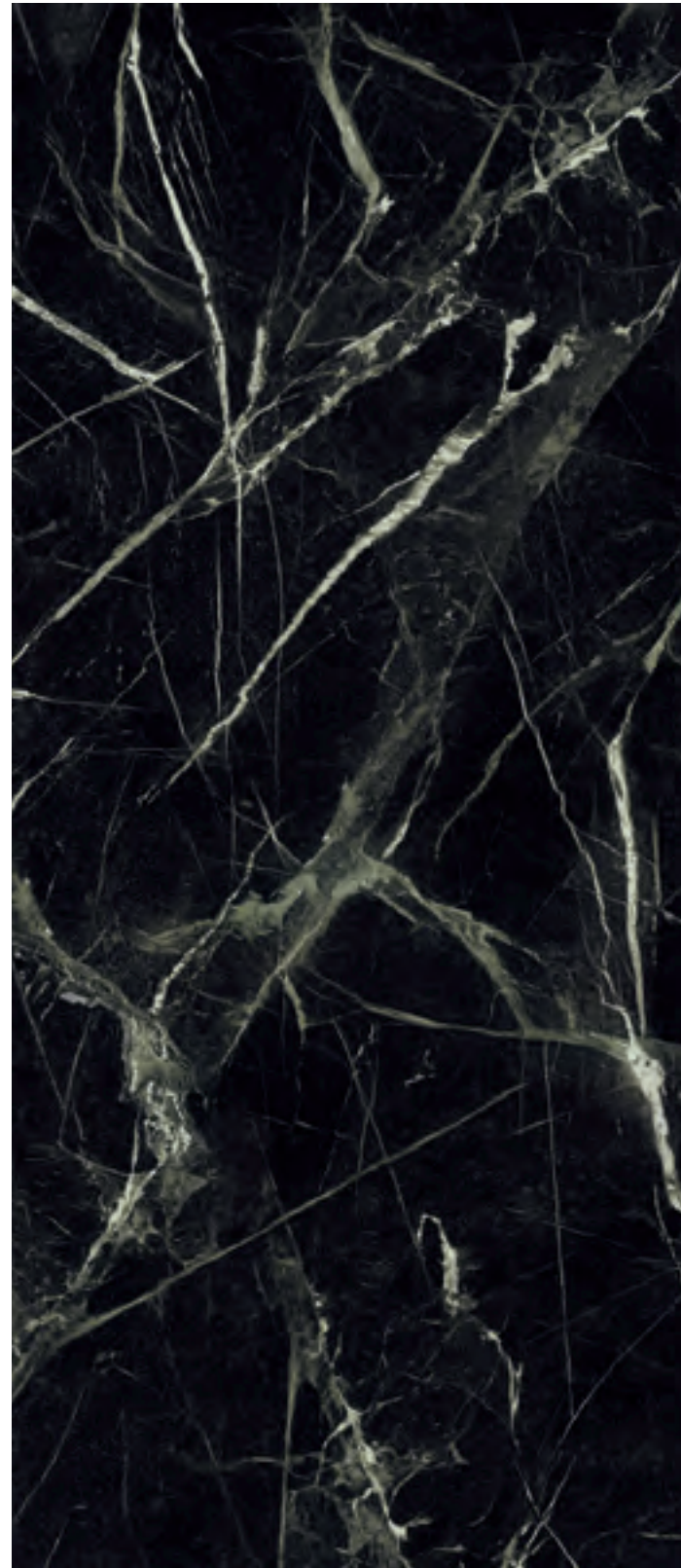

DEEP GREEN

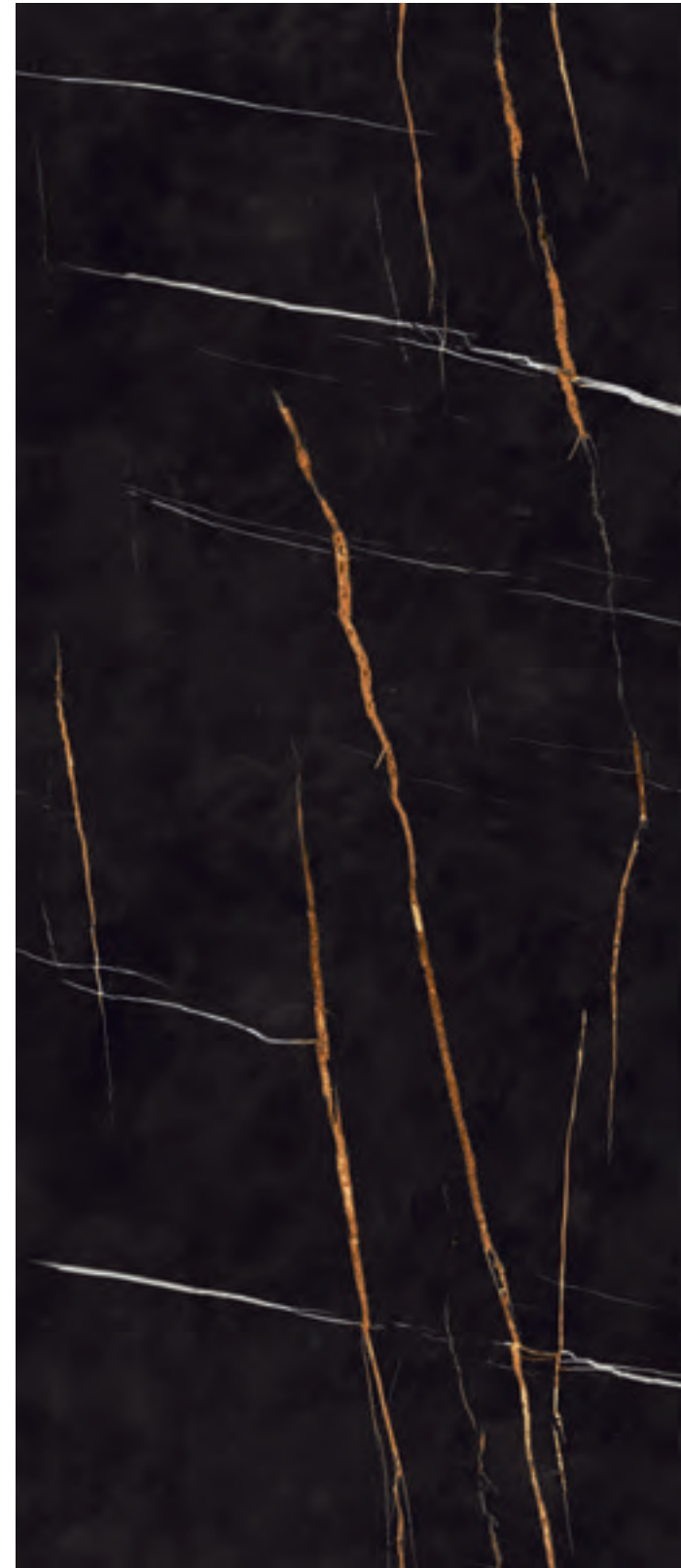

SAHARA NOIR

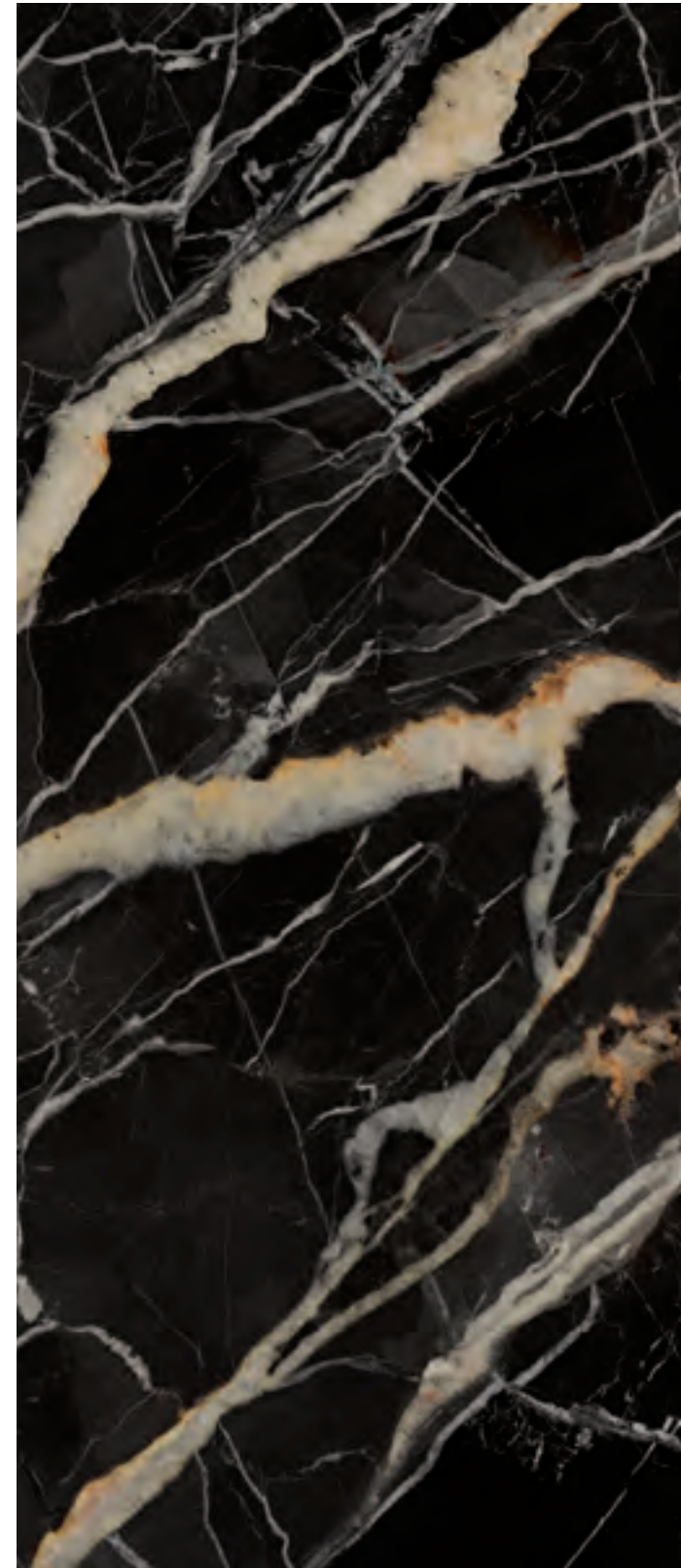

GOLDEN CARBON



MARQUINIA BLACK

	120x280 SOFT	120x120 SOFT	60x120 SOFT	120x280 LUX	120x120 LUX	60x120 LUX
DEEP GREEN	0010683	0010686	0010689	G27004	G0027014	G0027024
SAHARA NOIR	0009723	0010677	0010678	0009715	G0027056	G0027066
PRICE LIST €	F 97,90	F 83,50	F 60,50	F 124,50	F 108,90	F 78,90

	120x280 SOFT	120x120 SOFT	60x120 SOFT	120x280 LUX	120x120 LUX	60x120 LUX	120x120 NAT. PTECH R10 C 8,5MM	60x120 NAT. PTECH R10 C 8,5MM
GOLDEN CARBON	0010684	0010687	0010690	G27000	G0027010	G0027020		
MARQUINIA BLACK	0009722			0009721	G0027053	G0027063	0010672	0010673
PRICE LIST €	F 97,90	F 83,50	F 60,50	F 124,50	F 108,90	F 78,90	F 77,50	F 58,50

About us

Style
Group
Technology
6mm
Collections

Interiors

MARBLE
La Marmoteca

STONE
La Geoteca
Pietra Viva
Origini
Concept Stone
Burlington Stone

RESIN
I Pigmenti

SOLID COLORS
Chrome

METAL
Oxide

CONCRETE
Make

WOOD
Just Code
Just Nature
Just Color

Decor

Boiserie
Gioia

Technical Info

Technical info

Outdoor

STONE
La Geoteca
Pietra Viva
Origini
Fusion
Burlington Stone
Concept Stone
Antiqua
Soul
Suisse

RESIN
I Pigmenti

METAL
Oxide

CONCRETE
Make
Native
Mesh Up

WOOD
Just Code
Timber
Woodland

INDEX

La Marmoteca

INTERIORS MARBLE



GREY STONE



PEARL DELUXE

	120x280 SOFT	120x120 SOFT	60x120 SOFT3D	120x280 SOFT3D	120x280 LUX	120x120 LUX	60x120 LUX	120x120 NAT. PTECH R10 C 8,5MM	60x120 NAT. PTECH R10 C 8,5MM
GREY STONE	0008677				0008688	G0027052	G0027062	0006319	0006322
PEARL DELUXE	0010685	0010688	0010691	0010685	G27003	G0027013	G0027023		
PRICE LIST €	F 97,90	F 87,90	F 63,90	F 104,90	F 124,50	F 108,90	F 78,90	F 76,50	F 58,50



STATUARIO PREMIUM



STATUARIO SPIDER

	120x280 SOFT	120x280 SOFT3D	120x120 SOFT3D	60x120 SOFT3D	120x280 LUX	120x120 LUX	60x120 LUX	120x280 LUX3D	120x120 LUX3D	60x120 LUX3D	120x120 NAT. PTECH R10 C 8,5MM	60x120 NAT. PTECH R10 C 8,5MM
STATUARIO PREMIUM	0010602				0010598	G0027055	G0027065				0010392	0010397
STATUARIO SPIDER		0016081	0016082	0016083				0016088	0016089	0016090		
PRICE LIST €	F 97,90	F 104,90	F 87,90	F 63,90	F 124,50	F 108,90	F 78,90	F 139,9	F 118,9	F 88,5	F 76,50	F 58,50

About us

Style
Group
Technology
6mm
Collections

Interiors

MARBLE
La Marmoteca

STONE
La Geoteca
Pietra Viva
Origini
Concept Stone
Burlington Stone

RESIN
I Pigmenti

SOLID COLORS
Chrome

METAL
Oxide

CONCRETE
Make

WOOD
Just Code
Just Nature
Just Color

Decor

Boiserie
Gioia

Technical Info

Technical info

Outdoor

STONE
La Geoteca
Pietra Viva
Origini
Fusion
Burlington Stone
Concept Stone
Antiqua
Soul
Suisse

RESIN
I Pigmenti

METAL
Oxide

CONCRETE
Make
Native
Mesh Up

WOOD
Just Code
Timber
Woodland

INDEX

La Marmoteca

INTERIORS MARBLE

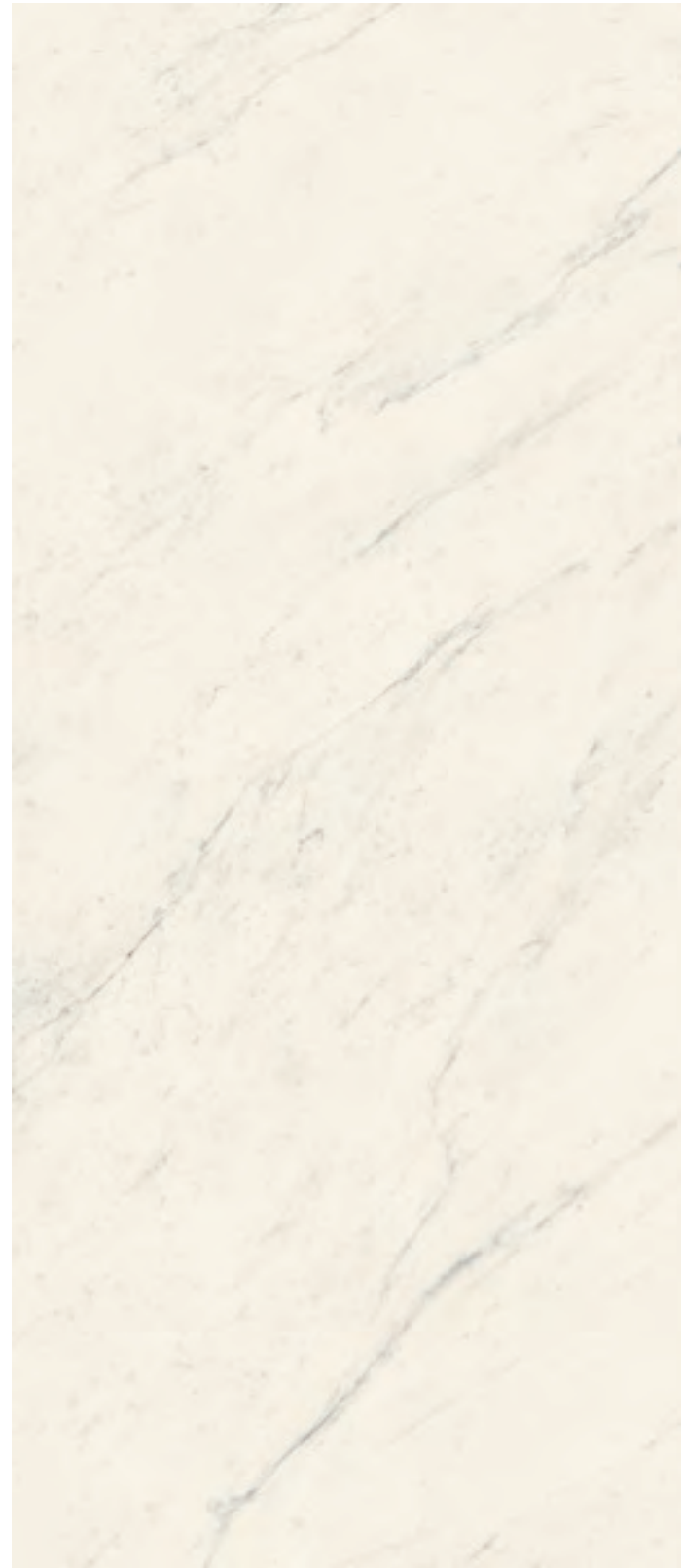

SAHARA WHITE

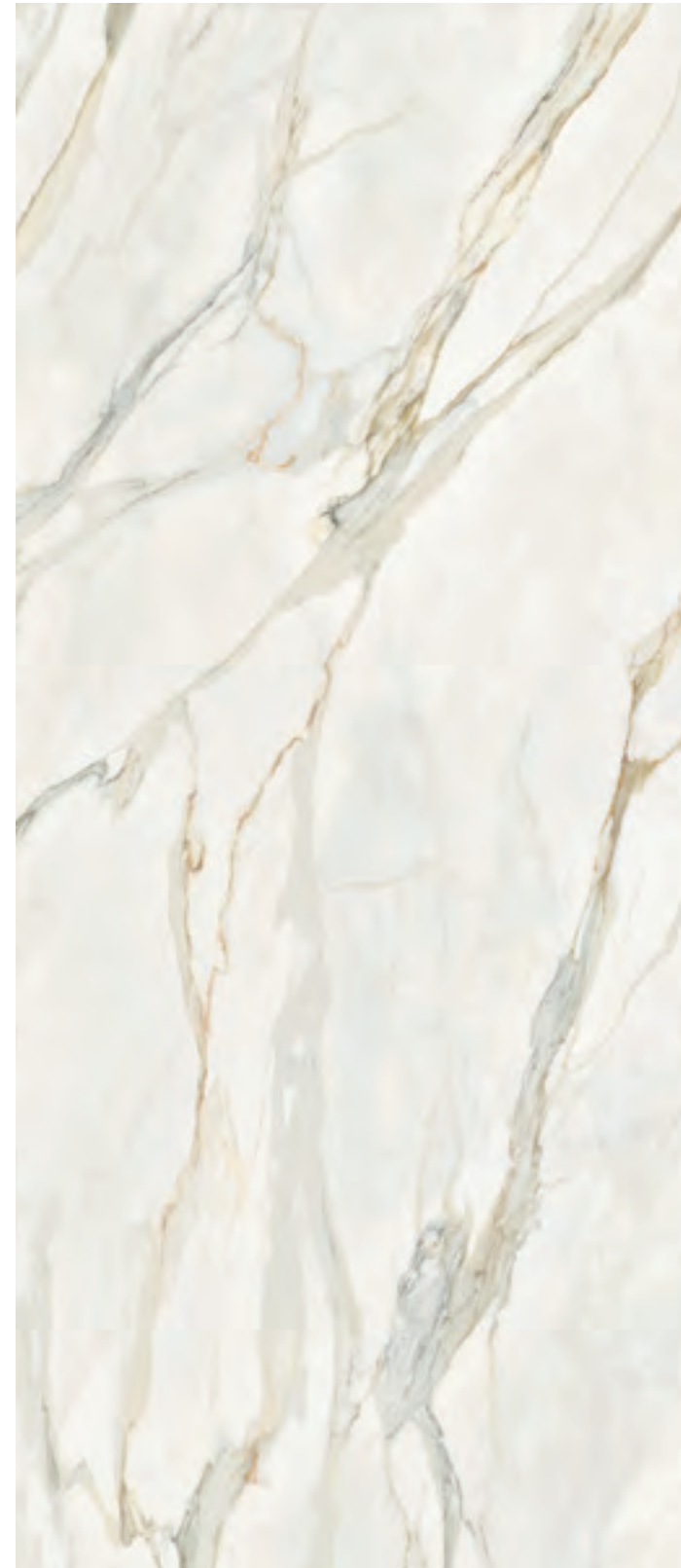

CALACATTA ELEGANCE



ANTIQUÉ BROWN

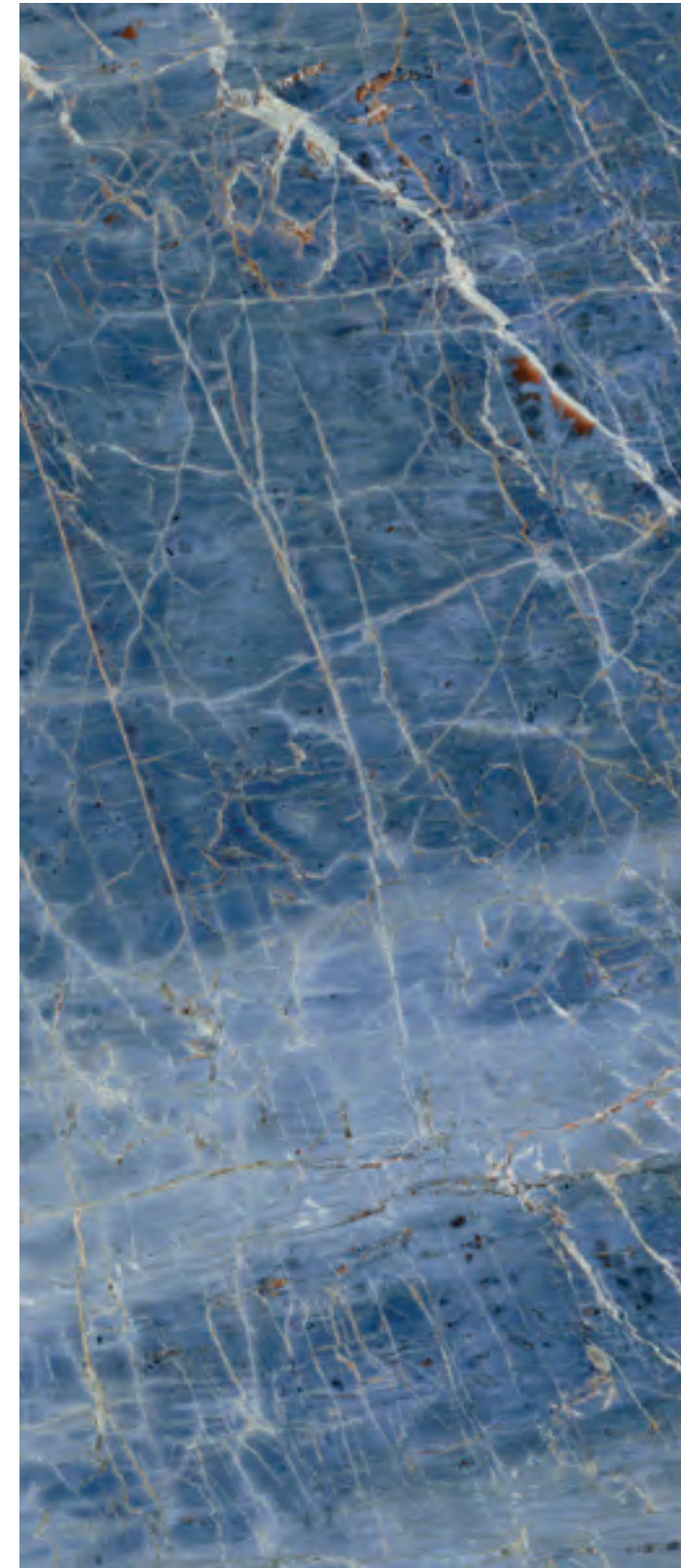

BLUE DENIM

	120x280 SOFT	120x120 SOFT	60x120 SOFT	120x280 LUX	120x120 LUX	60x120 LUX	120x120 LUX 8,5MM	60x120 LUX 8,5MM	120x120 NAT 8,5MM	60x120 NAT 8,5MM	120x120 NAT. PTECH R10 C 8,5MM	60x120 NAT. PTECH R10 C 8,5MM
SAHARA WHITE	0009725	0010674	0010675	0009717	G0027057	G0027067	0017769	0017765	0017779	0017781		
CALACATTA ELEGANCE	0010601			0010597	G0027051	G0027061					0010391	0010396
PRICE LIST €	F 97,90	F 83,50	F 60,50	F 124,50	F 108,90	F 78,90	F 108,90	F 78,90	F 108,90	F 78,90	F 76,50	F 58,50

	120x280 SOFT	120x120 SOFT	60x120 SOFT	120x280 LUX	120x120 LUX	60x120 LUX
ANTIQUÉ BROWN	0009726	0010680	0010681	0009718	G0027050	G0027060
BLUE DENIM				G27002	G0027012	G0027022
PRICE LIST €	F 97,90	F 83,50	F 60,50	F 124,50	F 108,90	F 78,90

About us

Style
Group
Technology
6mm
Collections

Interiors

MARBLE
La Marmoteca

STONE
La Geoteca
Pietra Viva
Origini
Concept Stone
Burlington Stone

RESIN
I Pigmenti

SOLID COLORS
Chrome

METAL
Oxide

CONCRETE
Make

WOOD
Just Code
Just Nature
Just Color

Decor

Boiserie
Gioia

Technical Info

Technical info

Outdoor

STONE
La Geoteca
Pietra Viva
Origini
Fusion
Burlington Stone
Concept Stone
Antiqua
Soul
Suisse

RESIN
I Pigmenti

METAL
Oxide

CONCRETE
Make
Native
Mesh Up

WOOD
Just Code
Timber
Woodland

INDEX

La Marmoteca

INTERIORS MARBLE



ONYX FLOW 4 FACES RANDOM

120x280
LUX

ONYX FLOW	0009719
PRICE LIST €	F 124,50

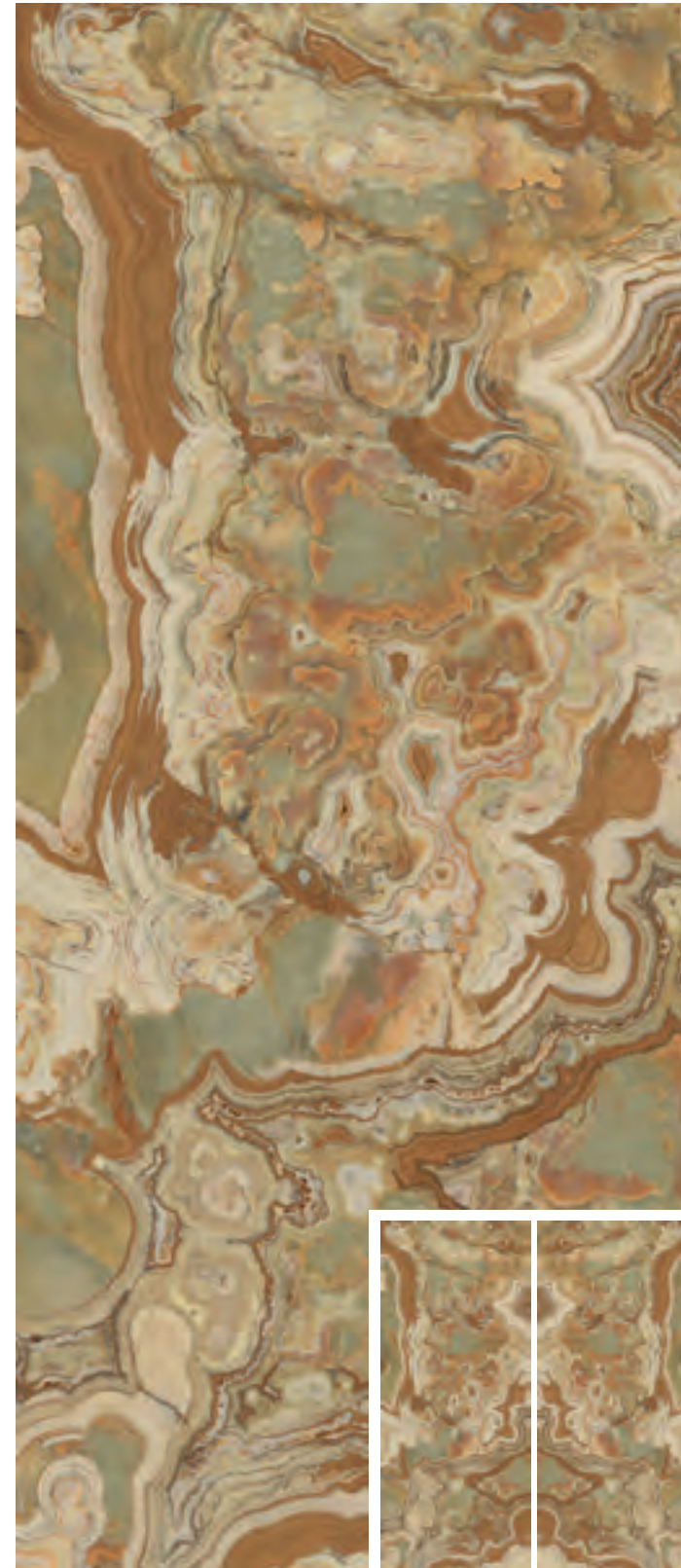

ONYX BRONZE A B

120x280
FACE A
LUX

120x280
FACE B
LUX

ONYX BRONZE	G27005	G27035
PRICE LIST €	F 124,50	F 124,50

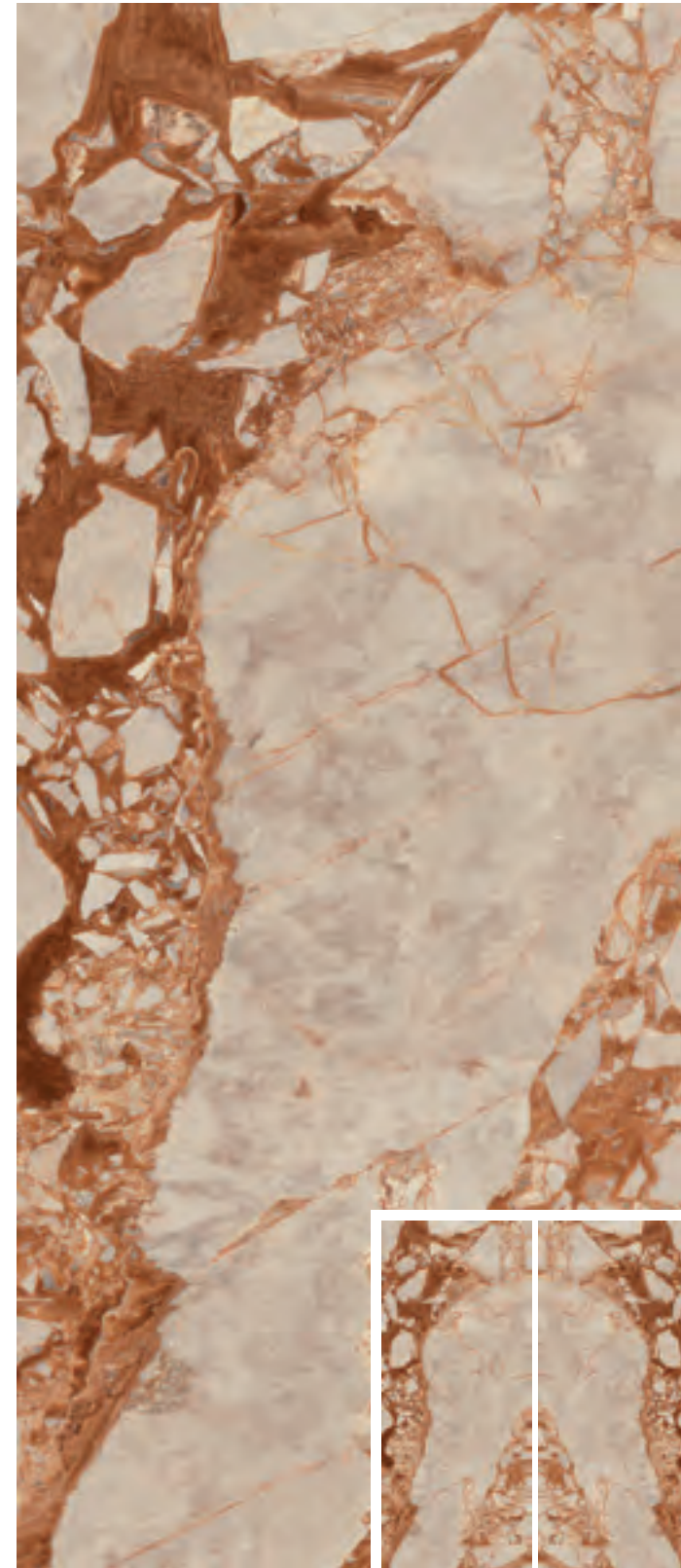

DREAMING ROSÈ A B

120x280
FACE A
LUX

120x280
FACE B
LUX

DREAMING ROSÈ	G27007	G27037
PRICE LIST €	F 124,50	F 124,50

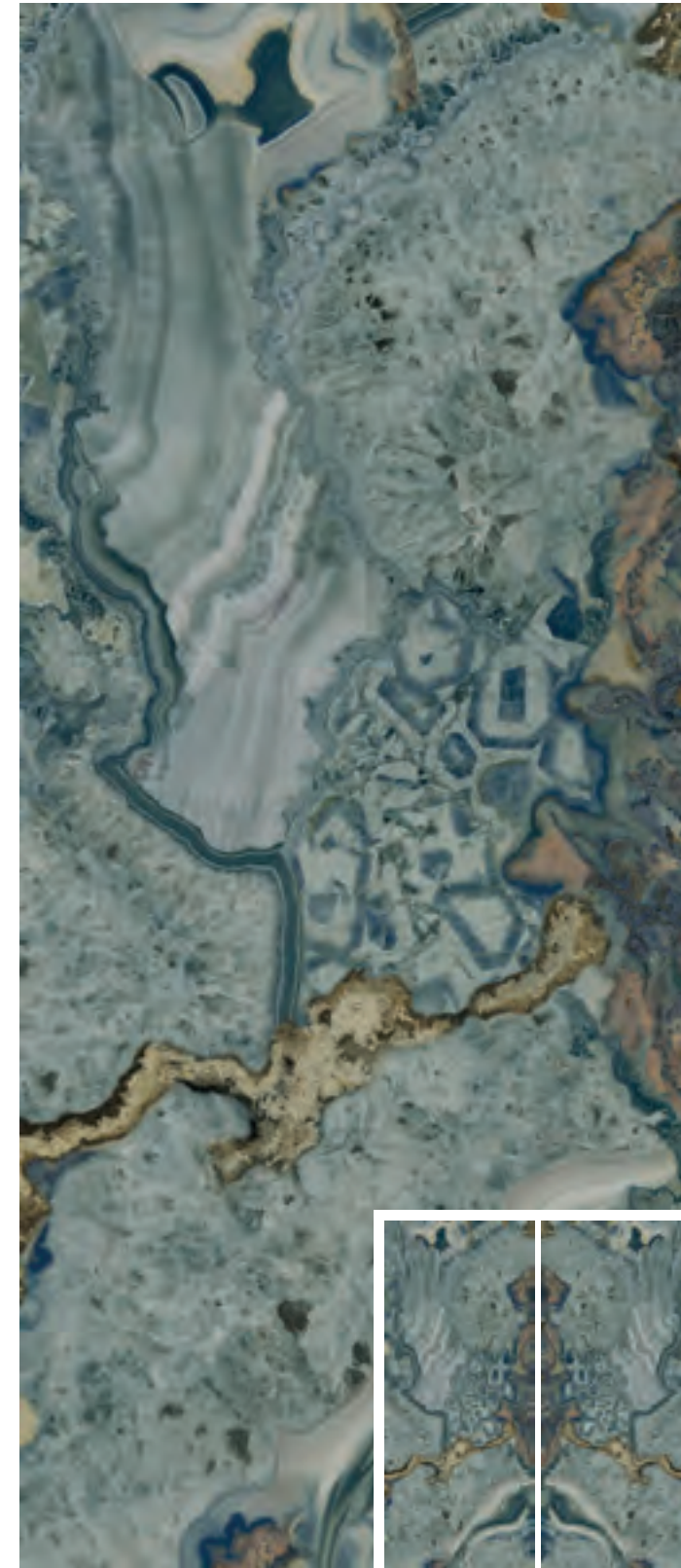

EMERALD QUARTZ A B

120x280
FACE A
LUX

120x280
FACE B
LUX

EMERALD QUARTZ	G27006	G27036
PRICE LIST €	F 124,50	F 124,50

About us

Style
Group
Technology
6mm
Collections

Interiors

MARBLE
La Marmoteca

STONE
La Geoteca
Pietra Viva
Origini
Concept Stone
Burlington Stone

RESIN
I Pigmenti

SOLID COLORS
Chrome

METAL
Oxide

CONCRETE
Make

WOOD
Just Code
Just Nature
Just Color

Decor

Boiserie
Gioia

Technical Info

Technical info

Outdoor

STONE
La Geoteca
Pietra Viva
Origini
Fusion
Burlington Stone
Concept Stone
Antiqua
Soul
Suisse

RESIN
I Pigmenti

METAL
Oxide

CONCRETE
Make
Native
Mesh Up

WOOD
Just Code
Timber
Woodland

INDEX

La Marmoteca

INTERIORS MARBLE

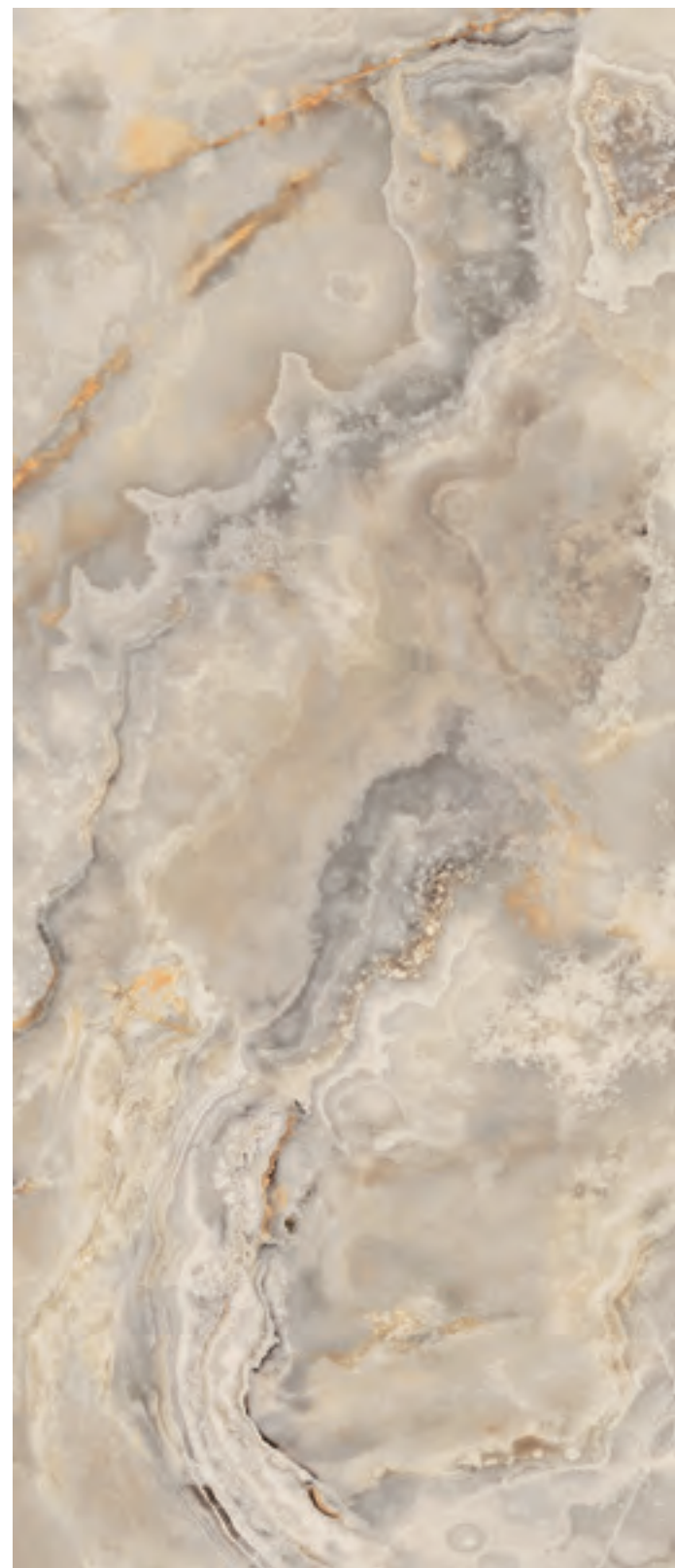

COSMIC IVORY



PATAGONIA EMERALD

	120x280 LUX	120x120 LUX	60x120 LUX
COSMIC IVORY	G27001	G0027011	G0027021
PATAGONIA EMERALD	0012774	0012777	0012778
PRICE LIST €	F 124,50	F 108,90	F 78,90



Wall
Patagonia Emerald 120x280 Lux

Floor
Pietra Viva Beige 120x120

About us

Style
Group
Technology
6mm
Collections

Interiors

MARBLE
La Marmoteca

STONE
La Geoteca
Pietra Viva
Origini
Concept Stone
Burlington Stone

RESIN
I Pigmenti

SOLID COLORS
Chrome

METAL
Oxide

CONCRETE
Make

WOOD
Just Code
Just Nature
Just Color

Decor

Boiserie
Gioia

Technical Info

Technical info

Outdoor

STONE

La Geoteca
Pietra Viva
Origini
Fusion
Burlington Stone
Concept Stone
Antiqua
Soul
Suisse

RESIN

I Pigmenti

METAL

Oxide

CONCRETE

Make
Native
Mesh Up

WOOD

Just Code
Timber
Woodland

INDEX

La Marmoteca

INTERIORS MARBLE

MOSAICI E PEZZI SPECIALI
SPECIAL TRIMS
PIECES SPECIALES
SONDERSTÜCKE

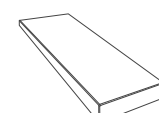
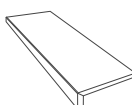
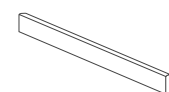

BATTISCOPA 5,5x120

	Nat. 8,5mm P6	Soft 6mm P6	Lux 6mm P6
STATUARIO SPIDER		0016084	0016091
VERDE PICASSO		0015042	0015060
GREY WONDER		0015044	0015059
FROZEN		0015045	0015033
PURE ONYX		0015043	0015035
PEARL DELUXE		0010905	0010897
BLUE DENIM			0010899
COSMIC IVORY			0010898
DEEP GREEN		0010903	0010895
GREY STONE	0006645		0010890
GOLDEN CARBON		0010904	0010896
SAHARA NOIR		0010901	0010893
MARQUINIA BLACK	0010915		0010891
SAHARA WHITE		0010900	0010892
STATUARIO PREMIUM	0010401		0010888
CALACATTA ELEGANCE	0010400		0010885
ANTIQUE BROWN		0010902	0010894
PATAGONIA EMERALD			0012780
PRICE LIST €	PZ 21,50	PZ 22,90	PZ 24,90

GRADONE TOP 32x120x4,5

	Nat. 8,5mm P1	Soft 6mm P1	Lux 6mm P1
		0016085	0016092
		0015046	0015062
		0015048	0015061
		0015049	0015036
		0015047	0015037
		0010959	0010927
			0010929
			0010928
		0010957	0010925
	0006648		0010920
		0010958	0010926
		0010955	0010923
	0010916		0010921
		0010954	0010922
	0010405		0010919
	0010404		0010914
		0010956	0010924
			0012781
	PZ 202,50	PZ 210,90	PZ 221,50

ANGOLARE TOP 32x120x4,5

	Nat. 8,5mm P1	Soft 6mm P1	Lux 6mm P1
		0016086 DX 0016087 SX	0016093 DX 0016094 SX
		0015050 DX 0015054 SX	0015064 DX 0015066 SX
		0015052 DX 0015056 SX	0015063 DX 0015065 SX
		0015053 DX 0015057 SX	0015038 DX 0015040 SX
		0015051 DX 0015055 SX	0015039 DX 0015041 SX
		0010965 DX 0010971 SX	0010939 DX 0010951 SX
			0010941 DX 0010953 SX
			0010940 DX 0010952 SX
		0010963 DX 0010969 SX	0010937 DX 0010949 SX
	0006654 DX 0006651 SX		0010932 DX 0010944 SX
		0010964 DX 0010970 SX	0010938 DX 0010950 SX
		0010961 DX 0010967 SX	0010935 DX 0010947 SX
	0010917 DX 0010918 SX		0010933 DX 0010945 SX
		0010960 DX 0010966 SX	0010934 DX 0010946 SX
	0010413 DX 0010409 SX		0010931 DX 0010943 SX
	0010412 DX 0010408 SX		0010930 DX 0010942 SX
		0010962 DX 0010968 SX	0010936 DX 0010948 SX
			0012782 DX 0012783 SX
	PZ 232,90	PZ 242,50	PZ 253,90

CARATTERISTICHE . CHARACTERISTICS . CARACTERISTIQUES . HAUPTEIGENSCHAFTEN

Classificazione secondo le norme EN 14411/G Bia
Classification in the accordance with . classification selon les normes . Einstufung nach den Normen
Gres porcellanato tutta massa . Full body porcelain
8,5MM: 120X120 (48"X48") NAT | 60X120 (24"X48") NAT

SHADE VARIATION VARIAZIONE CROMATICA

V3
moderata variazione
moderate variation

PROPRIETÀ FISICO-CHIMICHE PHYSICAL-CHEMICAL PROPERTIES	NORMA NORM	VALORE PRESCRITTO DALLE NORME VALUE PRESCRIBED FROM THE NORMS	VALORE GARDENIA* GARDENIA VALUE*
	B.C.R.A. C.A.	μ 0,19 SCIVOLOSITÀ PERICOLOSA . DANGEROUSLY SLIPPERY 0,20 < μ < 0,39 SCIVOLOSITÀ ECCESSIVA . EXCESSIVELY SLIPPERY 0,40 < μ < 0,74 ATTRITO SODDISFACENTE . SATISFACTORY GRIP μ 0,75 ATTRITO ECCELLENTE . EXCELLENT GRIP	> 0,40
	B.C.R.A. G.B.		> 0,40
RESISTENZA ALLO SCIVOLAMENTO . SLIP RESISTANCE	ASTM C 1028 (S.C.O.F.)	SLIP RESISTANT (> 0,60)	> 0,60 DRY > 0,60 WET
	DIN EN 16165 B	IN FUNZIONE DELL'AMBIENTE O DELLA ZONA DI LAVORO BASING ON THE ENVIRONMENT OR THE WORKING AREA	R10
	DIN EN 16165 A	-	A+B
	ANSI A 137-1:2012	\geq 0,42	> 0,42

*importante: rispondenti ai valori medi di produzione - nessun riferimento al lotto fornito. - Important: responding to average production values - no reference to the batch supplied



Wall
Sahara Noir 120x280 Soft

Floor
Just Nature Beige 20x120

About us

Style
Group
Technology
6mm
Collections

Outdoor

STONE
La Geoteca
Pietra Viva
Origini
Fusion
Burlington Stone
Concept Stone

Interiors

MARBLE
La Marmoteca

STONE
La Geoteca
Pietra Viva
Origini
Concept Stone
Burlington Stone

RESIN
I Pigmenti

SOLID COLORS
Chrome

METAL
Oxide

CONCRETE
Make

WOOD
Just Code
Just Nature
Just Color

Antiqua
Soul
Suisse

RESIN
I Pigmenti

METAL
Oxide

CONCRETE
Make
Native
Mesh Up

WOOD
Just Code
Timber
Woodland

Decor

Boiserie
Gioia

Technical Info

Technical info

INDEX

La Geoteca

GRES FINE PORCELLANATO
FINE PORCELAIN STONEWARE



2 SUPERFICI . SURFACES

Natural Ptech
Outdoor R11



4 FORMATI . SIZES

120X280 . 48"X110"
120X120 . 48"X48"
80X80 . 32"X32"
60X120 . 24"X48"



3 SPESSORI . THICKNESSES

6MM - 8,5MM - 20MM



TECNOLOGIA . TECHNOLOGY

3D tech
SOFT 3D
P. tech

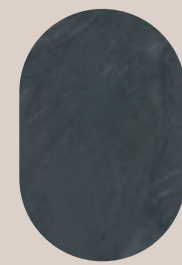

Cardoso



Serena

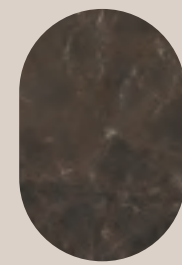

Negresco



Marfil



Brennero



Travertino Greige



Travertino Ivory Cross



Travertino Ivory Vein



Limestone



Provence



Ceppo di Gre



Vicenza



Bourgogne Beige



Bourgogne Silver

About us

Style
Group
Technology
6mm
Collections

Outdoor

STONE
La Geoteca
Pietra Viva
Origini
Fusion
Burlington Stone
Concept Stone
Antiqua
Soul
Suisse

Interiors

MARBLE
La Marmoteca

STONE
La Geoteca
Pietra Viva
Origini
Concept Stone
Burlington Stone

RESIN
I Pigmenti

SOLID COLORS
Chrome

METAL
Oxide

CONCRETE
Make

WOOD
Just Code
Just Nature
Just Color

RESIN
I Pigmenti

METAL
Oxide

CONCRETE
Make
Native
Mesh Up

WOOD
Just Code
Timber
Woodland

Decor

Boiserie
Gioia

Technical Info

Technical info

INDEX



Complete collection



Best box gallery



About us

Style
Group
Technology
6mm
Collections

Interiors

MARBLE
La Marmoteca

STONE
La Geoteca
Pietra Viva
Origini
Concept Stone
Burlington Stone

RESIN
I Pigmenti

SOLID COLORS
Chrome

METAL
Oxide

CONCRETE
Make

WOOD
Just Code
Just Nature
Just Color

Decor

Boiserie
Gioia

Technical Info

Technical info

Outdoor

STONE

La Geoteca
Pietra Viva
Origini
Fusion

Burlington Stone
Concept Stone

Antiqua
Soul
Suisse

RESIN

I Pigmenti

METAL

Oxide

CONCRETE

Make
Native
Mesh Up

WOOD

Just Code
Timber
Woodland

INDEX

Floor Outdoor
Brennero 80x80

Floor Indoor
Brennero 120x120

Wall
Brennero 120x280

Furniture
Gardenia Slabs Limestone



Floor
Serena 120x120

Wall
Plissé Serena 60x120
Serena 120x280

Furniture
Gardenia Slabs Serena



Floor
Travertino Ivory Cross 120x120

Wall
Travertino Ivory Vein 120x280

Furniture
Travertino Ivory Cross

About us

- Style
- Group
- Technology
- 6mm
- Collections

Interiors

- MARBLE**
- La Marmoteca
- STONE**
- La Geoteca
- Pietra Viva
- Origini
- Concept Stone
- Burlington Stone

- RESIN**
- I Pigmenti

- SOLID COLORS**
- Chrome

- METAL**
- Oxide

- CONCRETE**
- Make

- WOOD**
- Just Code
- Just Nature
- Just Color

Decor

- Boiserie
- Gioia

Technical Info

Technical info

Outdoor

- STONE**
- La Geoteca
- Pietra Viva
- Origini
- Fusion
- Burlington Stone
- Concept Stone
- Antiqua
- Soul
- Suisse

- RESIN**
- I Pigmenti

- METAL**
- Oxide

- CONCRETE**
- Make
- Native
- Mesh Up

- WOOD**
- Just Code
- Timber
- Woodland

INDEX



Floor Outdoor
Bourgogne Silver 80x80 R11 20mm

About us

Style
Group
Technology
6mm
Collections

Interiors

MARBLE
La Marmoteca

STONE
La Geoteca
Pietra Viva
Origini
Concept Stone
Burlington Stone

RESIN
I Pigmenti

SOLID COLORS
Chrome

METAL
Oxide

CONCRETE
Make

WOOD
Just Code
Just Nature
Just Color

Decor

Boiserie
Gioia

Technical Info

Technical info

Outdoor

STONE
La Geoteca
Pietra Viva
Origini
Fusion
Burlington Stone
Concept Stone
Antiqua
Soul
Suisse

RESIN
I Pigmenti

METAL
Oxide

CONCRETE
Make
Native
Mesh Up

WOOD
Just Code
Timber
Woodland

INDEX

La Geoteca

INTERIORS STONE



Floor
Travertino Ivory Vein 120x120

Wall
Travertino Ivory Vein 120x280

Furniture
I Pigmenti Mosaico Confetti Sand 29,3x33,3
Travertino Ivory Vein 120x280



Floor
Ceppo di Gre 60x120

Furniture
Gardenia Slabs Ceppo di Gre

About us

Style
Group
Technology
6mm
Collections

Interiors

MARBLE
La Marmoteca

STONE
La Geoteca
Pietra Viva
Origini
Concept Stone
Burlington Stone

RESIN
I Pigmenti

SOLID COLORS
Chrome

METAL
Oxide

CONCRETE
Make

WOOD
Just Code
Just Nature
Just Color

Decor

Boiserie
Gioia

Technical Info

Technical info

Outdoor

STONE
La Geoteca
Pietra Viva
Origini
Fusion
Burlington Stone
Concept Stone
Antiqua
Soul
Suisse

RESIN
I Pigmenti

METAL
Oxide

CONCRETE
Make
Native
Mesh Up

WOOD
Just Code
Timber
Woodland

INDEX



CARDOSO



SERENA

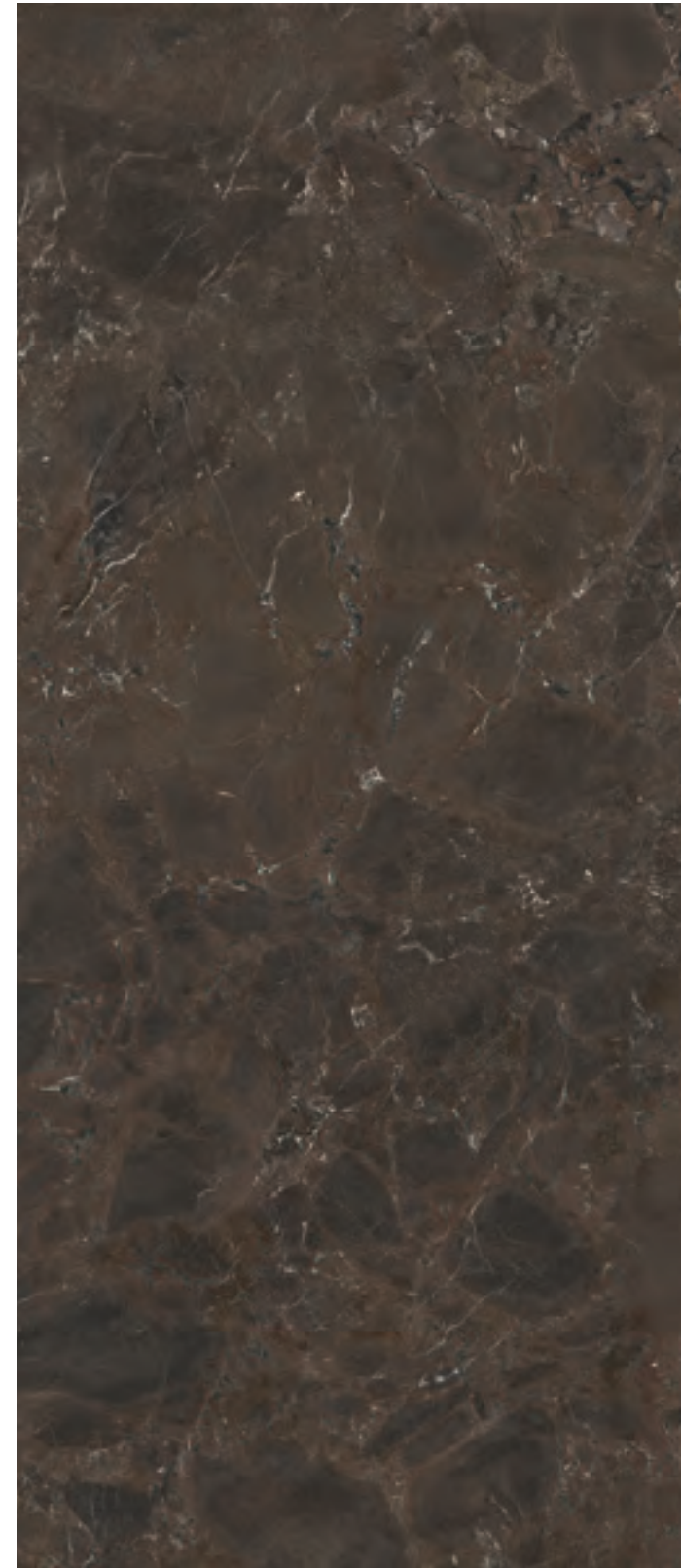

NEGRESKO



MARFIL

	120x280	120x120	60x120	80x80 8,5MM	60x120 20MM R11	80x80 20MM R11
CARDOSO	0011717	0011725	0011734	0012076		
SERENA	0011718	0011726	0011735	0012077	0014520	0012083
PRICE LIST €	F 94,90	F 76,50	F 58,50	F 54,90	F 89,50	F 84,50

	120x280	120x120	60x120	120x120 8,5MM	60x120 8,5MM	80x80 8,5MM
NEGRESKO	0011723	0011731	0011740	0011835	0011841	0012155
MARFIL	0011724	0011732	0011741			0012156
PRICE LIST €	F 94,90	F 76,50	F 58,50	F 76,50	F 58,50	F 54,90

About us

Style
Group
Technology
6mm
Collections

Interiors

MARBLE
La Marmoteca

STONE
La Geoteca
Pietra Viva
Origini
Concept Stone
Burlington Stone

RESIN
I Pigmenti

SOLID COLORS
Chrome

METAL
Oxide

CONCRETE
Make

WOOD
Just Code
Just Nature
Just Color

Decor

Boiserie
Gioia

Technical Info

Technical info

Outdoor

STONE
La Geoteca
Pietra Viva
Origini
Fusion
Burlington Stone
Concept Stone
Antiqua
Soul
Suisse

RESIN
I Pigmenti

METAL
Oxide

CONCRETE
Make
Native
Mesh Up

WOOD
Just Code
Timber
Woodland

INDEX



BRENNERO



TRAVERTINO GREIGE

	120x280	120x120	60x120	80x80 8,5MM	80x80 8,5MM R11	60x120 20MM R11	80x80 20MM R11
BRENNERO	0011721	0011729	0011738	0012079	0013054	0014522	0012085
TRAVERTINO GREIGE	0013064	0013065	0013066				
PRICE LIST €	F 94,90	F 76,50	F 58,50	F 54,90	F 56,90	F 89,50	F 84,50



TRAVERTINO IVORY VEIN



TRAVERTINO IVORY CROSS

	120x280	120x120	60x120	120x120 8,5MM	60x120 8,5MM	80x80 8,5MM	80x80 20MM R11
TRAVERTINO IVORY CROSS	0016135	0016136	0016138	0017438	0017439	0016144	0016183
TRAVERTINO IVORY VEIN	0012720	0016137	0016139	0012723	0012726		0016184
PRICE LIST €	F 94,90	F 76,50	F 58,50	F 76,50	F 58,50	F 54,90	F 84,50

About us

Style
Group
Technology
6mm
Collections

Interiors

MARBLE
La Marmoteca

STONE
La Geoteca
Pietra Viva
Origini
Concept Stone
Burlington Stone

RESIN
I Pigmenti

SOLID COLORS
Chrome

METAL
Oxide

CONCRETE
Make

WOOD
Just Code
Just Nature
Just Color

Decor

Boiserie
Gioia

Technical Info

Technical info

Outdoor

STONE
La Geoteca
Pietra Viva
Origini
Fusion
Burlington Stone
Concept Stone
Antiqua
Soul
Suisse

RESIN
I Pigmenti

METAL
Oxide

CONCRETE
Make
Native
Mesh Up

WOOD
Just Code
Timber
Woodland

INDEX



LIMESTONE



PROVENCE

	120x280	120x120	60x120	120x120 8,5MM	60x120 8,5MM	80x80 8,5MM	80x80 8,5MM R11	60x120 20MM R11	80x80 20MM R11
LIMESTONE	0011763	0011775	0011776	0010537	0010539	0012080	0013055	0014523	0012086
PROVENCE	0011720	0011728	0011737			0012081	0013056	0014524	0012087
PRICE LIST €	F 94,90	F 76,50	F 58,50	F 76,50	F 58,50	F 54,90	F 56,90	F 89,50	F 84,50



CEPPO DI GRE



VICENZA

	120x280	120x120	60x120	120x120 8,5MM	60x120 8,5MM	80x80 8,5MM	80x80 8,5MM R11	60x120 20MM R11	80x80 20MM R11
CEPPO DI GRE	0008674	0013116	0013117	0002946	0002949			0014525	0013072
VICENZA	0011719	0011727	0011736			0012078	0013053	0014521	0012084
PRICE LIST €	F 94,90	F 76,50	F 58,50	F 76,50	F 58,50	F 54,90	F 56,90	F 89,50	F 84,50

About us

Style
Group
Technology
6mm
Collections

Interiors

MARBLE
La Marmoteca

STONE
La Geoteca
Pietra Viva
Origini
Concept Stone
Burlington Stone

RESIN
I Pigmenti

SOLID COLORS
Chrome

METAL
Oxide

CONCRETE
Make

WOOD
Just Code
Just Nature
Just Color

Decor

Boiserie
Gioia

Technical Info

Technical info

Outdoor

STONE
La Geoteca
Pietra Viva
Origini
Fusion
Burlington Stone
Concept Stone
Antiqua
Soul
Suisse

RESIN
I Pigmenti

METAL
Oxide

CONCRETE
Make
Native
Mesh Up

WOOD
Just Code
Timber
Woodland

INDEX



BOURGOGNE BEIGE

BOURGOGNE SILVER

	120x280	120x120	60x120	120x120 8,5MM	60x120 8,5MM	80x80 8,5MM	80x80 20MM R11
BOURGOGNE BEIGE	0016055	0016057	0016059	0017777	0017788	0016061	0016026
BOURGOGNE SILVER	0016056	0016058	0016060	0017778	0017789	0016062	0016027
PRICE LIST €	F 94,90	F 76,50	F 58,50	F 76,50	F 58,50	F 54,90	F 84,50



Floor
Bourgogne Silver 120x120

Wall
Bourgogne Silver 120x280

About us

- Style
- Group
- Technology
- 6mm
- Collections

Interiors

- MARBLE**
- La Marmoteca
- STONE**
- La Geoteca
- Pietra Viva
- Origini
- Concept Stone
- Burlington Stone
- RESIN**
- I Pigmenti
- SOLID COLORS**
- Chrome
- METAL**
- Oxide
- CONCRETE**
- Make
- WOOD**
- Just Code
- Just Nature
- Just Color

Decor

- Boiserie
- Gioia

Technical Info

Technical info

Outdoor

- STONE**
- La Geoteca
- Pietra Viva
- Origini
- Fusion
- Burlington Stone
- Concept Stone
- Antiqua
- Soul
- Suisse
- RESIN**
- I Pigmenti
- METAL**
- Oxide
- CONCRETE**
- Make
- Native
- Mesh Up
- WOOD**
- Just Code
- Timber
- Woodland

INDEX



Floor
Bourgogne Beige Mix Floor

La Geoteca

INTERIORS STONE



60x90 MIX FLOOR
TRAVERTINO IVORY CROSS NAT
60017959

F 94.50

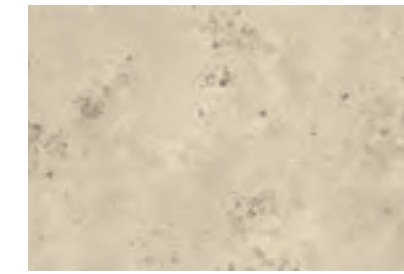

60x90 MIX FLOOR
BOURGOGNE BEIGE NAT
0017960

F 94.50

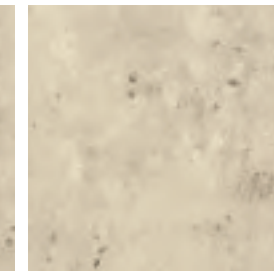

SCHEMI DI POSA INSTALLATION PATTERNS

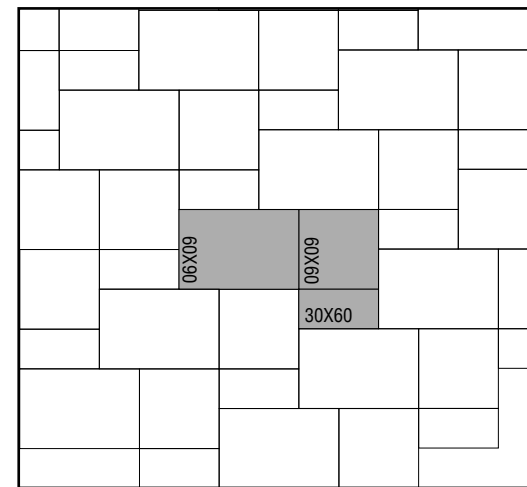

MIX FLOOR 100% ■

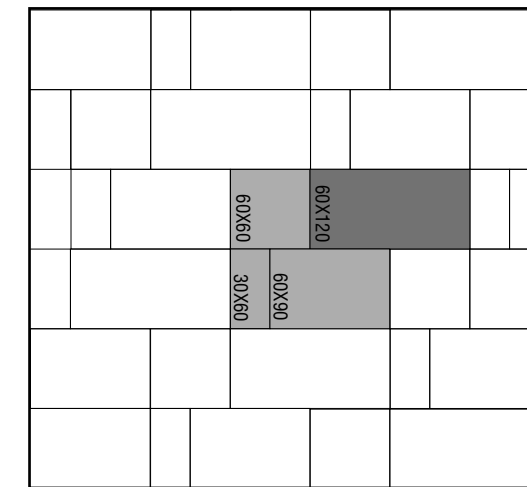

MIX FLOOR 60% ■
60x120 40% ■

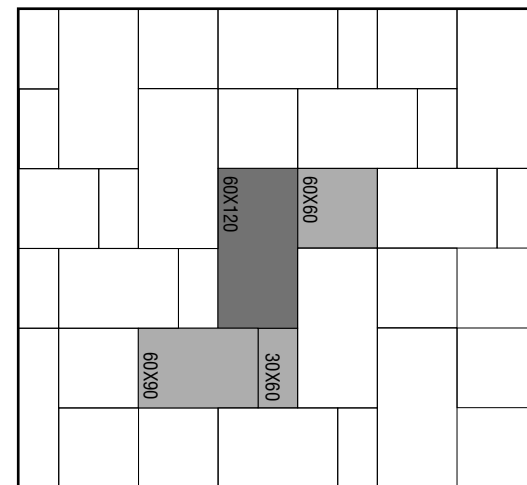

MIX FLOOR 60% ■
60x120 40% ■

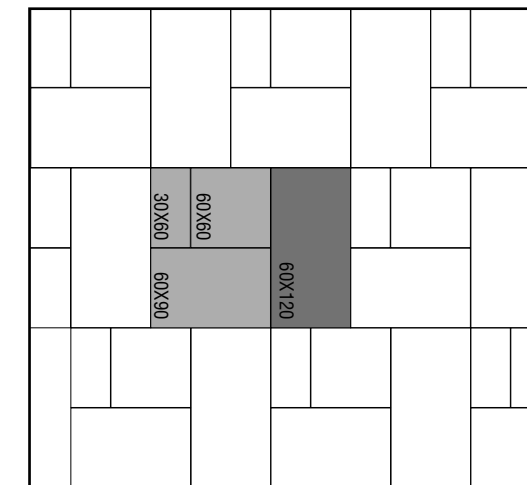

MIX FLOOR 60% ■
60x120 40% ■

About us

Style
Group
Technology
6mm
Collections

Interiors

MARBLE
La Marmoteca

STONE
La Geoteca
Pietra Viva
Origini
Concept Stone
Burlington Stone

RESIN
I Pigmenti

SOLID COLORS
Chrome

METAL
Oxide

CONCRETE
Make

WOOD
Just Code
Just Nature
Just Color

Decor

Boiserie
Gioia

Outdoor

STONE
La Geoteca
Pietra Viva
Origini
Fusion
Burlington Stone
Concept Stone
Antiqua
Soul
Suisse

RESIN
I Pigmenti

METAL
Oxide

CONCRETE
Make
Native
Mesh Up

WOOD
Just Code
Timber
Woodland

Technical Info

Technical info

INDEX

La Geoteca

INTERIORS STONE

DECORO PLISSÉ 60X120 8MM F 79,50



60x120
LIMESTONE
0016140



60x120
BOURGOGNE BEIGE
0016141



60x120
SERENA
0016634

DECORO WAVE 60X120 8,5MM F 79,50



60x120
TRAVERTINO IVORY WAVE
0012866



Wall
Plissé Limestone 60x120

About us

Style
Group
Technology
6mm
Collections

Interiors

MARBLE
La Marmoteca

STONE
La Geoteca
Pietra Viva
Origini
Concept Stone
Burlington Stone

RESIN
I Pigmenti

SOLID COLORS
Chrome

METAL
Oxide

CONCRETE
Make

WOOD
Just Code
Just Nature
Just Color

Decor

Boiserie
Gioia

Technical Info

Technical info

Outdoor

STONE
La Geoteca
Pietra Viva
Origini
Fusion

Burlington Stone
Concept Stone
Antiqua
Soul
Suisse

RESIN
I Pigmenti

METAL
Oxide

CONCRETE
Make
Native
Mesh Up

WOOD
Just Code
Timber
Woodland

INDEX

La Geoteca

DECORO GAME 60X120 7MM F 79,50

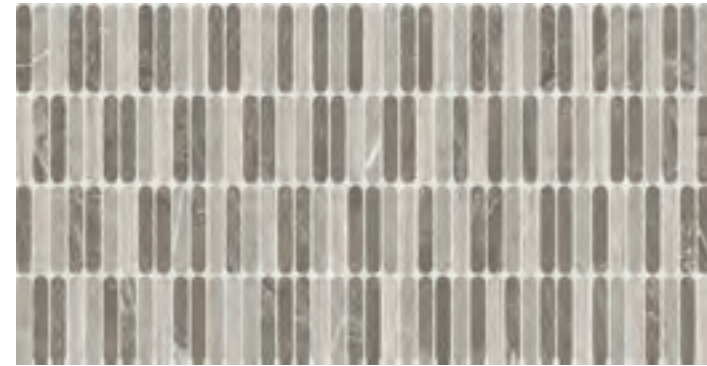

60x120
GAME COLD
0012044

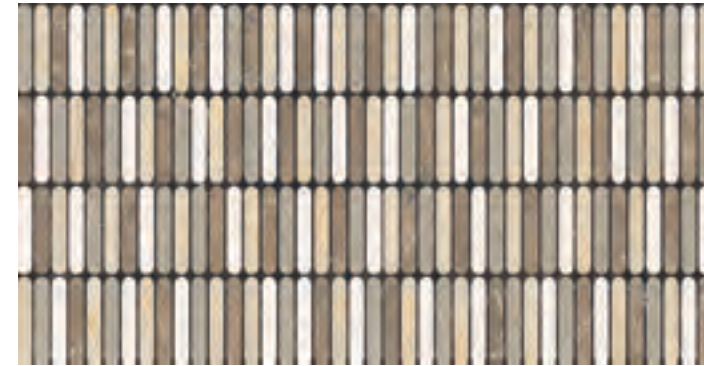

60x120
GAME WARM
0012045



Wall
Game Cold 60x120

Floor
Cardoso 60x120

INTERIORS STONE

MOSAICI E PEZZI SPECIALI SPECIAL TRIMS PIECES SPECIALES SONDERSTÜCKE

BATTISCOPIA MOLATO

5,5x80 - 6mm 8	5,5x120 - 6mm 6	5,5x120 - 8,5mm 6
-------------------	--------------------	----------------------

CARDOSO	0012814	0012797	
SERENA	0012815	0012798	
VICENZA	0012817	0012799	
BRENNERO	0012818	0012800	
LIMESTONE	0012819	0012801	0010550
PROVENCE	0012820	0012802	
NEGRESCO	0012821	0012803	0012624
MARFIL	0012822	0012804	
CEPPO DI GRE	-	0013073	0002964
TRAVERTINO GREIGE	-	0013089	
BOURGOGNE BEIGE	0016066	0016064	0017962
BOURGOGNE SILVER	0016067	0016065	0017963
TRAVERTINO IVORY CROSS	0016147	0016145	0012708
TRAVERTINO IVORY VEIN	-	0016146	0017638

PRICE LIST €	PZ 12,90	PZ 21,50	PZ 21,50
--------------	----------	----------	----------

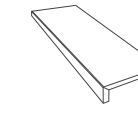

GRADONE TOP

120x32x4,5 - 6mm 1	120x32x4,5 - 8,5mm 1
-----------------------	-------------------------

0012823	
0012824	
0012825	
0012826	
0012827	0010555
0012828	
0012829	0012630
0012830	
0013090	0002967
0013091	
0016068	0017965
0016069	0017966
0016148	0017640
0016149	0012711

PZ 202,50	PZ 202,50
-----------	-----------

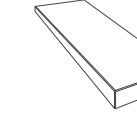

GRADONE ANGOLARE

120x32x4,5 - 6mm 1	120x32x4,5 - 8,5mm 1
-----------------------	-------------------------

0012831 DX		
0012839 SX		
0012832 DX		
0012840 SX		
0012833 DX		
0012841 SX		
0012834 DX		
0012842 SX		
0012835 DX		0010566 DX
0012843 SX		0010561 SX
0012836 DX		
0012844 SX		
0012837 DX		0012642 DX
0012845 SX		0012636 SX
0012838 DX		
0012846 SX		
0013092 DX		0002973 DX
0013094 SX		0002970 SX
0013093 DX		
0013095 SX		
0016070 DX		0017975 DX
0016072 SX		0017968 SX
0016071 DX		0017976 DX
0016073 SX		0017969 SX
0016150 DX		0017644 DX
0016152 SX		0017642 SX
0016151 DX		0012717 DX
0016153 SX		0012714 SX

PZ 232,90	PZ 232,90
-----------	-----------

I dati relativi a imballaggi e pesi possono subire delle variazioni . Informations and details related to packaging and weight are subject to change. Les données concernant emballage et poids sont sujettes à variations . Die Angaben über verpackungen und gewichte sind nicht bindend

CARATTERISTICHE . CHARACTERISTICS . CARACTERISTIQUES . HAUPTEIGENSCHAFTEN

Classificazione secondo le norme EN 14411/G Bia
Classification in the accordance with . classification selon les normes . Einstufung nach den Normen
Gres porcellanato tutta massa . Full body porcelain

6MM: 120X280 (48"X112") NAT. | 120X120 (48"X48") NAT. | 60X120 (24"X48") NAT. | 40X120 (16"X48") NAT
8,5MM: 80X80 (32"X32") NAT
20MM: 80X80 (32"X32") R11

PROPRIETÀ FISICO-CHIMICHE PHYSICAL-CHEMICAL PROPERTIES	NORMA NORM	VALORE PRESCRITTO DALLE NORME VALUE PRESCRIBED FROM THE NORMS	VALORE GARDENIA* GARDENIA VALUE*
RESISTENZA ALLO SCIVOLAMENTO . SLIP RESISTANCE	B.C.R.A. C.A.	μ 0,19 SCIVOLOSITÀ PERICOLOSA . DANGEROUSLY SLIPPERY $0,20 < \mu < 0,39$ SCIVOLOSITÀ ECCESSIVA . EXCESSIVELY SLIPPERY	> 0,40
	B.C.R.A. G.B.	$0,40 < \mu < 0,74$ ATTRITO SODDISFACENTE . SATISFACTORY GRIP μ 0,75 ATTRITO ECCELLENTE . EXCELLENT GRIP	> 0,40
RESISTENZA ALLO SCIVOLAMENTO . SLIP RESISTANCE	ASTM C 1028 (S.C.O.F.)	SLIP RESISTANT (> 0,60)	> 0,60 DRY > 0,60 WET
	DIN EN 16165 B	IN FUNZIONE DELL'AMBIENTE O DELLA ZONA DI LAVORO BASING ON THE ENVIRONMENT OR THE WORKING AREA	R10 (NAT.) - R11 (R11)
	DIN EN 16165 A	-	B (NAT.) - C (R11)
	ANSI A 137-1-2012 BS 7976-2:2002	$\geq 0,42$ > 36	> 0,42 +36 WET

*importante: rispondenti ai valori medi di produzione - nessun riferimento al lotto fornito. - Important: responding to average production values - no reference to the batch supplied

SHADE VARIATION

VARIAZIONE CROMATICA

V3
moderata variazione
moderate variation



About us

Style
Group
Technology
6mm
Collections

Interiors

MARBLE

La Marmoteca

STONE

La Geoteca

Pietra Viva

Origini

Concept Stone

Burlington Stone

RESIN

I Pigmenti

SOLID COLORS

Chrome

METAL

Oxide

CONCRETE

Make

WOOD

Just Code

Just Nature

Just Color

Decor

Boiserie

Gioia

Technical Info

Technical info

Outdoor

STONE

La Geoteca

Pietra Viva

Origini

Fusion

Burlington Stone

Concept Stone

Antiqua

Soul

Suisse

RESIN

I Pigmenti

METAL

Oxide

CONCRETE

Make

Native

Mesh Up

WOOD

Just Code

Timber

Woodland

INDEX

Pietra Viva

GRES FINE PORCELLANATO
FINE PORCELAIN STONEWARE



4 SUPERFICI . SURFACES

- Lux 3d
- Antique 3D
- Natural Ptech
- Outdoor R11



4 FORMATI . SIZES

- 120X280 . 48"X110"
- 120X120 . 48"X48"
- 80X80 . 32"X32"
- 60X120 . 24"X48"



3 SPESSORI . THICKNESSES

- 6MM - 8,5MM - 20MM



TECNOLOGIA . TECHNOLOGY

- 3D tech
- P. tech



Grey



Antracite



Ivory



Beige



Complete collection



Best box gallery



Floor
Ivory 120x120

Wall
Ivory Lux 3D 120x280

About us

- Style
- Group
- Technology
- 6mm
- Collections

Outdoor

- STONE**
- La Geoteca
- Pietra Viva
- Origini
- Fusion
- Burlington Stone
- Concept Stone
- Antiqua
- Soul
- Suisse

Interiors

- MARBLE**
- La Marmoteca

- STONE**
- La Geoteca
- Pietra Viva
- Origini
- Concept Stone
- Burlington Stone

- RESIN**
- I Pigmenti

- SOLID COLORS**
- Chrome

- METAL**
- Oxide

- CONCRETE**
- Make

- WOOD**
- Just Code
- Just Nature
- Just Color

- RESIN**
- I Pigmenti

- METAL**
- Oxide

- CONCRETE**
- Make

- NATIVE**
- Mesh Up

- WOOD**
- Just Code

- TIMBER**
- Woodland

Decor

- Boiserie
- Gioia

Technical Info

Technical info

INDEX



Floor
Antracite Antique 3D 60x120

About us

Style
Group
Technology
6mm
Collections

Interiors

MARBLE
La Marmoteca

STONE
La Geoteca
Pietra Viva
Origini
Concept Stone
Burlington Stone

RESIN
I Pigmenti

SOLID COLORS
Chrome

METAL
Oxide

CONCRETE
Make

WOOD
Just Code
Just Nature
Just Color

Decor

Boiserie
Gioia

Technical Info

Technical info

Outdoor

STONE
La Geoteca
Pietra Viva
Origini
Fusion
Burlington Stone
Concept Stone
Antiqua
Soul
Suisse

RESIN
I Pigmenti

METAL
Oxide

CONCRETE
Make
Native
Mesh Up

WOOD
Just Code
Timber
Woodland

INDEX

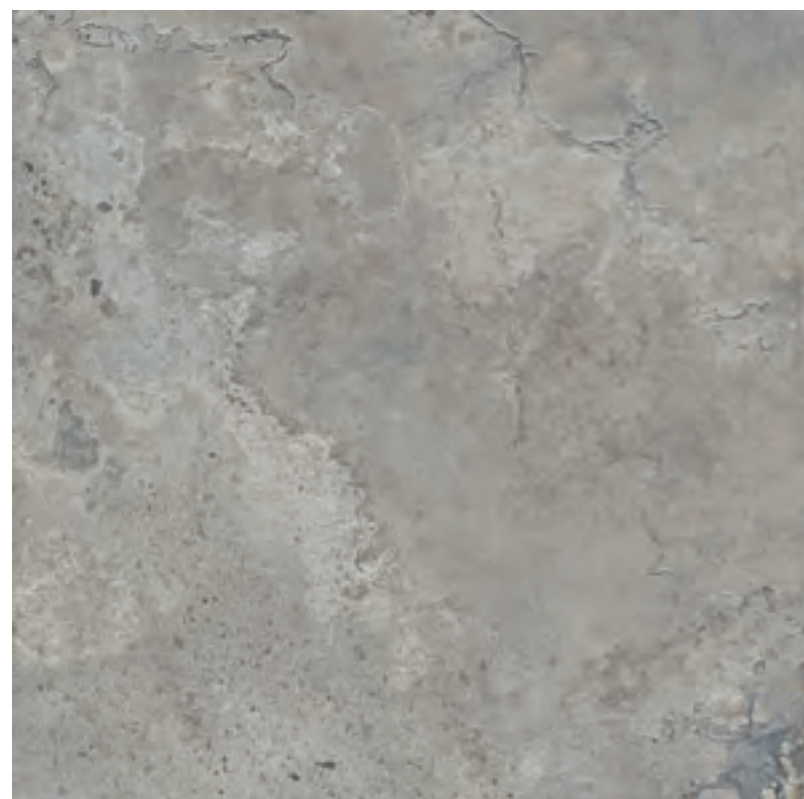

GREY

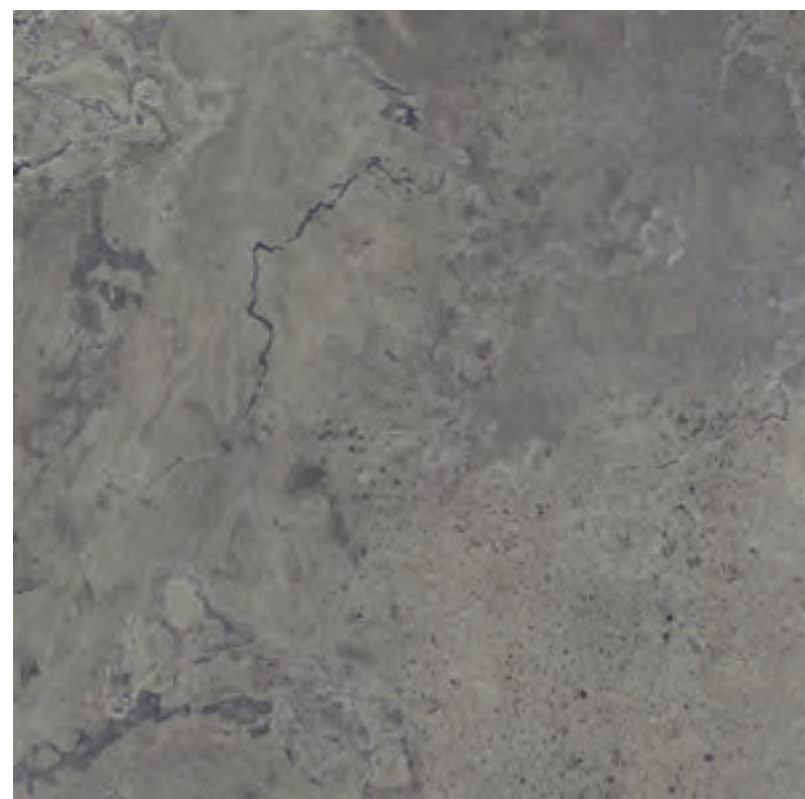

ANTRACITE



IVORY



BEIGE

	80x80	60x120 ANT3D	60x120	120x120 ANT3D	120x120	80x80 R11 20MM	60x60 R11 20MM
GREY	0012262	0011118	0012912	0012254	0012908	0012266	0014518
ANTRACITE	0012263	0011119	0012913	0012257	0012909		
PRICE LIST €	F 54,90	F 88,50	F 58,50	F 118,90	F 76,50	F 84,50	F 75,90

	80x80	60x120 ANT3D	60x120	120x120 ANT3D	120x120	120x280 6MM LUX3D	80x80 R11 20MM	60x60 R11 20MM
BEIGE	0012265	0011974	0012915	0012260	0012911	0014862	0012267	0014519
IVORY	0012264	0011973	0012914	0012258	0012910	0014863		
PRICE LIST €	F 54,90	F 88,50	F 58,50	F 118,90	F 76,50	F 139,50	F 84,50	F 75,90

About us

Style
Group
Technology
6mm
Collections

Interiors

MARBLE
La Marmoteca

STONE
La Geoteca
Pietra Viva
Origini
Concept Stone
Burlington Stone

RESIN
I Pigmenti

SOLID COLORS
Chrome

METAL
Oxide

CONCRETE
Make

WOOD
Just Code
Just Nature
Just Color

Decor

Boiserie
Gioia

Technical Info

Technical info

Outdoor

STONE

La Geoteca
Pietra Viva
Origini
Fusion

Burlington Stone
Concept Stone

Antiqua
Soul
Suisse

RESIN
I Pigmenti

METAL
Oxide

CONCRETE
Make

Native
Mesh Up

WOOD
Just Code

Timber
Woodland

INDEX

Pietra Viva

INTERIORS STONE

MOSAICI E PEZZI SPECIALI
SPECIAL TRIMS
PIECES SPECIALES
SONDERSTÜCKE

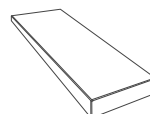
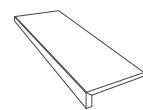
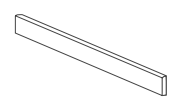

BATTISCOPA MOLATO

5,5x80 5,5x120
8 6

GREY 0012271 0012275

ANTRACITE 0012272 0012276

IVORY 0012273 0012277

BEIGE 0012274 0012278

PRICE LIST € PZ 12,90 PZ 22,50

GRADONE TOP

120x32x4,5
1

0012279

0012280

0012281

0012282

PZ 212,50

GRADONE ANGOLARE

120x32x4,5
1

0012283 DX
0012287 SX

0012284 DX
0012289 SX

0012285 DX
0012290 SX

0012286 DX
0012291 SX

PZ 244,50

I dati relativi a imballaggi e pesi possono subire delle variazioni . Informations and details related to packaging and weight are subject to change. Les données concernant emballage et poids sont sujettes à variations . Dieangaben über verpackungen und gewichte sind nicht bindend

CARATTERISTICHE . CHARACTERISTICS . CARACTERISTIQUES . HAUPTEIGENSCHAFTEN

Classificazione secondo le norme EN 14411/G B1a

Classification in the accordance with . classification selon les normes . Einstufung nach den Normen

Gres porcellanato pressato a secco . Dry-pressed ceramic tiles . Fine porcelaine . Stonewereporcelain

8,5MM: 120X280 (48"X112") ANT. 3D TECH | 120X120 (48"X48") ANT. 3D TECH | 60X120 (24"X48") ANT. 3D TECH | 8,5MM: 80X80 (32"X32") NAT. P.TECH

PROPRIETÀ FISICO-CHIMICHE PHYSICAL-CHEMICAL PROPERTIES	NORMA NORM	VALORE PRESCRITTO DALLE NORME VALUE PRESCRIBED FROM THE NORMS	VALORE GARDENIA* GARDENIA VALUE*
RESISTENZA ALLO SCIVOLAMENTO . SLIP RESISTANCE	B.C.R.A. C.A.	μ 0,19 SCIVOLosità PERICOLOSA . DANGEROUSLY SLIPPERY 0,20 < μ < 0,39 SCIVOLosità ECCESSIVA . EXCESSIVELY SLIPPERY 0,40 < μ < 0,74 ATTRITO SODDISFACENTE . SATISFACTORY GRIP μ 0,75 ATTRITO ECCELLENTE . EXCELLENT GRIP	> 0 ,40 (NAT.)
	B.C.R.A. G.B.		
RESISTENZA ALLO SCIVOLAMENTO . SLIP RESISTANCE	ASTM C 1028 (S.C.O.F.)	SLIP RESISTANT (> 0,60)	> 0 ,60 (NAT.)
	DIN EN 16165 B	IN FUNZIONE DELL'AMBIENTE O DELLA ZONA DI LAVORO BASING ON THE ENVIRONMENT OR THE WORKING AREA	R10 (NAT.)
	DIN EN 16165 A	-	A+B (NAT.)
	ANSI A 137-1:2012	≥ 0,42	> 0 ,42 (NAT.)

20 MM: 80X80 (32"X32") R11 | 60X60 (24"X24") R11

PROPRIETÀ FISICO-CHIMICHE PHYSICAL-CHEMICAL PROPERTIES	NORMA NORM	VALORE PRESCRITTO DALLE NORME VALUE PRESCRIBED FROM THE NORMS	VALORE GARDENIA* GARDENIA VALUE*
RESISTENZA ALLO SCIVOLAMENTO . SLIP RESISTANCE	B.C.R.A. C.A.	μ 0,19 SCIVOLosità PERICOLOSA . DANGEROUSLY SLIPPERY 0,20 < μ < 0,39 SCIVOLosità ECCESSIVA . EXCESSIVELY SLIPPERY 0,40 < μ < 0,74 ATTRITO SODDISFACENTE . SATISFACTORY GRIP μ 0,75 ATTRITO ECCELLENTE . EXCELLENT GRIP	> 0 ,40
	B.C.R.A. G.B.		
RESISTENZA ALLO SCIVOLAMENTO . SLIP RESISTANCE	ASTM C 1028 (S.C.O.F.)	SLIP RESISTANT (> 0,60)	> 0 ,60 (DRY) > 0 ,60 (WET)
	DIN EN 16165 B	IN FUNZIONE DELL'AMBIENTE O DELLA ZONA DI LAVORO BASING ON THE ENVIRONMENT OR THE WORKING AREA	R10 (NAT.) - R11 (R11)
	DIN EN 16165 A	-	B (NAT.) - C (R11)
	ANSI A 137-1:2012	≥ 0,42	> 0 ,42
	BS 7976-2:2002	> 36	+ 36 WET

*importante: rispondenti ai valori medi di produzione - nessun riferimento al lotto fornito. - Important: responding to average production values - no reference to the batch supplied

SHADE VARIATION

VARIAZIONE CROMATICA

V3
moderata variazione
moderate variation



Floor
Antracite 120x120

Wall
Just Code miele 20x120
Gioia Corteccia 60x120

About us

Style
Group
Technology
6mm
Collections

Interiors

MARBLE
La Marmoteca

STONE
La Geoteca
Pietra Viva
Origini
Concept Stone
Burlington Stone

RESIN
I Pigmenti

SOLID COLORS
Chrome

METAL
Oxide

CONCRETE
Make

WOOD
Just Code
Just Nature
Just Color

Decor

Boiserie
Gioia

Technical Info

Technical info

Outdoor

STONE
La Geoteca
Pietra Viva
Origini
Fusion
Burlington Stone
Concept Stone
Antiqua
Soul
Suisse

RESIN
I Pigmenti

METAL
Oxide

CONCRETE
Make
Native
Mesh Up

WOOD
Just Code
Timber
Woodland

INDEX

Origini

GRES FINE PORCELLANATO
FINE PORCELAIN STONEWARE



2 SUPERFICI . SURFACES

Natural R10
Outdoor R11



5 FORMATI . SIZES

100X100 . 40"X40"
80X80 . 32"X32"
60X120 . 24"X48"
60X60 . 24"X24"
30X60 . 12"X24



2 SPESSORI . THICKNESSES

8,5MM



Crux White



Crux Grey



Bolgheri



Gris Royal



Complete
collection



Floor
Gris Royal 100x100

About us

Style
Group
Technology
6mm
Collections

Outdoor

STONE
La Geoteca
Pietra Viva
Origini
Fusion
Burlington Stone
Concept Stone
Antiqua
Soul
Suisse

Interiors

MARBLE
La Marmoteca

STONE
La Geoteca
Pietra Viva
Origini
Concept Stone
Burlington Stone

RESIN
I Pigmenti

SOLID COLORS
Chrome

METAL
Oxide

CONCRETE
Make

WOOD
Just Code
Just Nature
Just Color

RESIN
I Pigmenti

METAL
Oxide

CONCRETE
Make
Native
Mesh Up

WOOD
Just Code
Timber
Woodland

Decor

Boiserie
Gioia

Technical Info

Technical info

INDEX



Floor
Bolgheri 60x60

Origini

INTERIORS STONE



Floor
Crux Grey 100x100

About us

- Style
- Group
- Technology
- 6mm
- Collections

Interiors

MARBLE
La Marmoteca

STONE
La Geoteca
Pietra Viva
Origini
Concept Stone
Burlington Stone

RESIN
I Pigmenti

SOLID COLORS
Chrome

METAL
Oxide

CONCRETE
Make

WOOD
Just Code
Just Nature
Just Color

Decor

- Boiserie
- Gioia

Technical Info

Technical info

Outdoor

STONE
La Geoteca
Pietra Viva
Origini
Fusion
Burlington Stone
Concept Stone
Antiqua
Soul
Suisse

RESIN
I Pigmenti

METAL
Oxide

CONCRETE
Make
Native
Mesh Up

WOOD
Just Code
Timber
Woodland

INDEX



CRUX WHITE *



CRUX GREY *



GRIS ROYAL



BOLGHERI

	100x100	80x80	60x120	60x60	30x60	80x80 R11
CRUX WHITE	G0073542	G0073522	G0073592	G0073582	G0073572	
CRUX GREY	G0073541	G0073521	G0073591	G0073581W		G0073701
PRICE LIST €	F 62,50	F 49,50	F 56,50	F 44,50	F 44,50	F 52,50

	100x100	80x80	60x120	60x60	30x60	80x80 R11
GRIS ROYAL	G0073544	G0073524	G0073594	G0073584		G0073704
BOLGHERI	G0073543	G0073523	G0073593	G0073583	G0073573	
PRICE LIST €	F 62,50	F 49,50	F 56,50	F 44,50	F 44,50	F 52,50

About us

- Style
- Group
- Technology
- 6mm
- Collections

Interiors

- MARBLE**
 - La Marmoteca
- STONE**
 - La Geoteca
 - Pietra Viva
 - Origini
 - Concept Stone
 - Burlington Stone
- RESIN**
 - I Pigmenti
- SOLID COLORS**
 - Chrome
- METAL**
 - Oxide
- CONCRETE**
 - Make
- WOOD**
 - Just Code
 - Just Nature
 - Just Color

Decor

- Boiserie
- Gioia

Outdoor

- STONE**
 - La Geoteca
 - Pietra Viva
 - Origini
 - Fusion
 - Burlington Stone
 - Concept Stone
 - Antiqua
 - Soul
 - Suisse
- RESIN**
 - I Pigmenti
- METAL**
 - Oxide
- CONCRETE**
 - Make
 - Native
 - Mesh Up
- WOOD**
 - Just Code
 - Timber
 - Woodland

Technical Info

Technical info

INDEX



Floor
Crux White 60x120

INTERIORS STONE

MOSAICI E PEZZI SPECIALI
SPECIAL TRIMS
PIECES SPECIALES
SONDERSTÜCKE

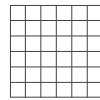

MOSAICO T36

33,3x33,3

CRUX WHITE

G0073772

CRUX GREY

G0073771

GRIS ROYAL

G0073774

BOLGHERI

G0073773

PRICE LIST €

PZ 19,50

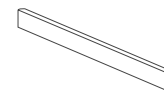

BATTISCOPA MOLATO

8x60

10

8x80

10

8x100

4

GML73582

GML73522

GML73542

GML73581

GML73521

GML73541

GML73584

GML73524

GML73544

GML73583

GML73523

GML73543

PZ 10,50

PZ 12,90

PZ 15,50

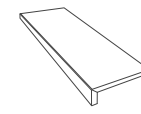

GRADONE TOP

120x32x4,5

1

G0073712

G0073711

G0073714

G0073713

PZ 202,50

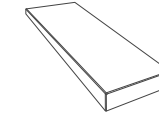

GRADONE ANGOLARE

120x32x4,5

1

G0073722 SX

G0073732 DX

G0073721 SX

G0073731 DX

G0073724 SX

G0073734 DX

G0073723 SX

G0073733 DX

PZ 232,90

I dati relativi a imballaggi e pesi possono subire delle variazioni . Informations and details related to packaging and weight are subject to change. Les données concernant emballage et poids sont sujettes à variations . Dieangaben über verpackungen und gewichte sind nicht bindend

CARATTERISTICHE . CHARACTERISTICS . CARACTERISTIQUES . HAUPT-EIGENSCHAFTEN

Classificazione secondo le norme EN 14411/G Bia

Classification in the accordance with . classification selon les normes . Einstufung nach den Normen

Gres porcellanato tutta massa . Full body porcelain

SHADE VARIATION

VARIAZIONE CROMATICA



*Colori/Colours: Crux Grey

8,5MM:100X100 (40"X40") NAT, LUX 180X80 (32"X32") NAT, R11 | 40X80 (16"X32") NAT | 60X120 (24"X48") NAT, LUX | 60X60 (24"X24") NAT | 30X60 (12"X24") NAT

PROPRIETÀ FISICO-CHIMICHE PHYSICAL-CHEMICAL PROPERTIES	NORMA NORM	VALORE PRESCRITTO DALLE NORME VALUE PRESCRIBED FROM THE NORMS	VALORE GARDENIA* GARDENIA VALUE*
	B.C.R.A. C.A.	μ 0,19 SCIVOLOSITÀ PERICOLOSA . DANGEROUSLY SLIPPERY 0,20 < μ < 0,39 SCIVOLOSITÀ ECCESSIVA . EXCESSIVELY SLIPPERY 0,40 < μ < 0,74 ATTRITO SODDISFACENTE . SATISFACTORY GRIP μ 0,75 ATTRITO ECCELLENTE . EXCELLENT GRIP	> 0,40
	B.C.R.A. G.B.		> 0,40
	ASTM C 1028 (S.C.O.F.)	SLIP RESISTANT (> 0,60)	> 0,60 DRY > 0,60 WET
RESISTENZA ALLO SCIVOLAMENTO . SLIP RESISTANCE	DIN EN 16165 B	IN FUNZIONE DELL'AMBIENTE O DELLA ZONA DI LAVORO BASING ON THE ENVIRONMENT OR THE WORKING AREA	R10 (NAT.) - R11 (R11)
	DIN EN 16165 A	-	B (NAT.) - B (R11)
	ANSI A 137-1:2012	\geq 0,42	> 0,42

*importante: rispondenti ai valori medi di produzione - nessun riferimento al lotto fornito. - Important: responding to average production values - no reference to the batch supplied

* IL CRUX È CARATTERIZZATO DA FORTE STONALIZZAZIONE, SI CONSIGLIA DI SCEGLIERE DA PIÙ SCATOLE CONTEMPORANEAMENTE E DI POSARE UNA PORZIONE DI MATERIALE A SECCO PER GARANTIRE LA VARIABILITÀ E CASUALITÀ DELLA SUPERFICIE FINITA. * CRUX HAS A STRONG GRAPHIC VARIATION, WE RECOMMEND TO CHOOSE FEW PIECES AT THE SAME TIME FROM DIFFERENT BOXES AND TO LAY THEM DRY FIRST IN ORDER TO GRANT THE CORRECT VARIABILITY AND RANDOMNESS AS AN END RESULT. * LE CRUX EST UN PRODUIT FORT NUANCÉ. NOUS CONSEILLONS, AU MOMENT DE LA POSE, DE SORTIR LES CARREAUX DE PLUSIEURS BÔTES EN MÊME TEMPS ET DE POSER UNE PORTION DE SOL AVANT ENCOLLAGÉ POUR GARANTIR LA VARIABILITÉ ET CAUSALITÉ DE LA SURFACE POSÉE. * DAS CRUX ZEICHNET SICH DURCH EIN STARKES FARBSPIEL AUS, ES IST EMPFEHLENSWERT, AUS MEHREREN KARTONS GLEICHZEITIG ZU WÄHLEN UND EINEN TEIL DES MATERIALS OHNE KLEBSTOFF ZU VERLEGEN, UM DIE VARIABILITÄT UND ZUFÄLLIGKEIT DER FERTIGEN OBERFLÄCHE ZU GEWÄHRLEISTEN.

About us

Style
Group
Technology
6mm
Collections

Interiors

MARBLE

La Marmoteca

STONE

La Geoteca

Pietra Viva

Origini

Concept Stone

Burlington Stone

RESIN

I Pigmenti

SOLID COLORS

Chrome

METAL

Oxide

CONCRETE

Make

WOOD

Just Code

Just Nature

Just Color

Decor

Boiserie

Gioia

Technical Info

Technical info

Outdoor

STONE

La Geoteca

Pietra Viva

Origini

Fusion

Burlington Stone

Concept Stone

Antiqua

Soul

Suisse

RESIN

I Pigmenti

METAL

Oxide

CONCRETE

Make

Native

Mesh Up

WOOD

Just Code

Timber

Woodland

INDEX

Concept Stone

GRES FINE PORCELLANATO
FINE PORCELAIN STONEWARE



2 SUPERFICI . SURFACES

Natural R10
Outdoor R11



2 FORMATI . SIZES

80X80 . 32"X32"
40X80 . 16"X32"



2 SPESSORI . THICKNESSES

8,5MM - 20MM



Bianco



Grigio



Antracite



Nero



Beige chiaro



Sabbia



Bruno Medio



Complete
collection



Wall
Antracite 80x80

About us

Style
Group
Technology
6mm
Collections

Outdoor

STONE
La Geoteca
Pietra Viva
Origini
Fusion
Burlington Stone
Concept Stone
Antiqua
Soul
Suisse

Interiors

MARBLE
La Marmoteca

STONE
La Geoteca
Pietra Viva
Origini
Concept Stone
Burlington Stone

RESIN
I Pigmenti

SOLID COLORS
Chrome

METAL
Oxide

CONCRETE
Make

WOOD
Just Code
Just Nature
Just Color

RESIN
I Pigmenti

METAL
Oxide

CONCRETE
Make
Native
Mesh Up

WOOD
Just Code
Timber
Woodland

Decor

Boiserie
Gioia

Technical Info

Technical info

INDEX



Wall
Nero 80x80

Concept Stone

INTERIORS STONE



Wall
Sabbia 40x80

About us

- Style
- Group
- Technology
- 6mm
- Collections

Interiors

MARBLE

- La Marmoteca

STONE

- La Geoteca
- Pietra Viva
- Origini
- Concept Stone
- Burlington Stone

RESIN

- I Pigmenti

SOLID COLORS

- Chrome

METAL

- Oxide

CONCRETE

- Make

WOOD

- Just Code
- Just Nature
- Just Color

Decor

- Boiserie
- Gioia

Technical Info

Technical info

Outdoor

STONE

- La Geoteca
- Pietra Viva
- Origini
- Fusion

Burlington Stone

Concept Stone

Antiqua

Soul

Suisse

RESIN

I Pigmenti

METAL

Oxide

CONCRETE

Make

Native

Mesh Up

WOOD

Just Code

Timber

Woodland

INDEX

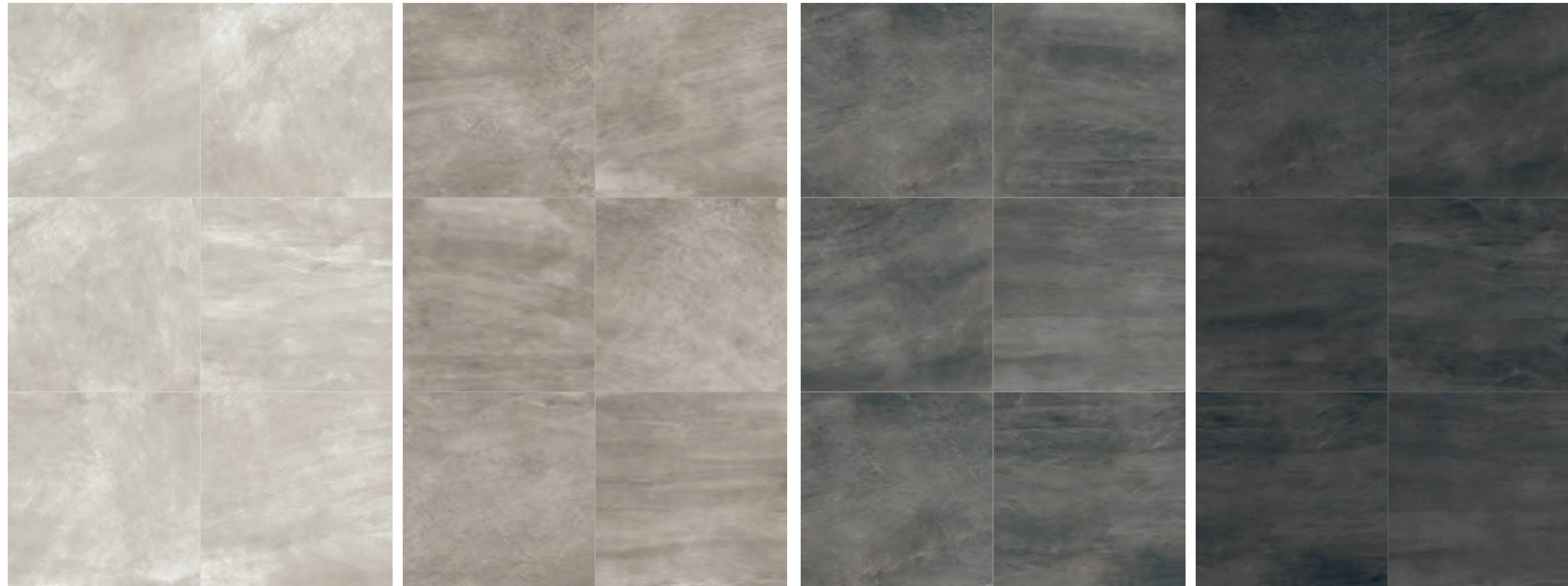

BIANCO

GRIGIO

ANTRACITE

NERO

	80x80	40x80	40x80 R11	80x80 R11 20MM
BIANCO	G0054100	G0054110		
GRIGIO	G0054103	G0054113	G0054473	G0054123
PRICE LIST €	F 49,50	F 48,50	F 51,90	F 84,50

	80x80	40x80	40x80 R11	80x80 R11 20MM
ANTRACITE	G0054105	G0054115	G0054475	G0054125
NERO	G0054106	G0054116		
PRICE LIST €	F 49,50	F 48,50	F 51,90	F 84,50

About us

Style
Group
Technology
6mm
Collections

Interiors

MARBLE
La Marmoteca

STONE
La Geoteca
Pietra Viva
Origini
Concept Stone
Burlington Stone

RESIN
I Pigmenti

SOLID COLORS
Chrome

METAL
Oxide

CONCRETE
Make

WOOD
Just Code
Just Nature
Just Color

Decor

Boiserie
Gioia

Outdoor

STONE
La Geoteca
Pietra Viva
Origini
Fusion
Burlington Stone
Concept Stone
Antiqua
Soul
Suisse

RESIN
I Pigmenti

METAL
Oxide

CONCRETE
Make
Native
Mesh Up

WOOD
Just Code
Timber
Woodland

Technical Info

Technical info

INDEX

Concept Stone

INTERIORS STONE



BEIGE CHIARO

SABBIA

BRUNO MEDIO

	80x80	40x80	80x80 R11	40x80 R11	80x80 R11 20MM
BEIGE CHIARO	G0054101	G0054111			
SABBIA	G0054102	G0054112	G0054462	G0054472	G0054122
PRICE LIST €	F 49,50	F 48,50	F 52,50	F 51,90	F 84,50

	80x80	40x80	80x80 R11	40x80 R11	80x80 R11 20 MM
BRUNO MEDIO	G0054104	G0054114	G0054464	G0054474	G0054124
PRICE LIST €	F 49,50	F 48,50	F 52,50	F 51,90	F 84,50

About us

- Style
- Group
- Technology
- 6mm
- Collections

Interiors

- MARBLE**
- La Marmoteca
- STONE**
- La Geoteca
- Pietra Viva
- Origini
- Concept Stone
- Burlington Stone

RESIN

- I Pigmenti

SOLID COLORS

- Chrome

METAL

- Oxide

CONCRETE

- Make

WOOD

- Just Code
- Just Nature
- Just Color

Decor

- Boiserie
- Gioia

Outdoor

STONE

- La Geoteca
- Pietra Viva
- Origini
- Fusion
- Burlington Stone
- Concept Stone

MARBLE

- Antiqua
- Soul
- Suisse

RESIN

- I Pigmenti

METAL

- Oxide

CONCRETE

- Make
- Native
- Mesh Up

WOOD

- Just Code
- Timber
- Woodland

INDEX

Technical Info

Technical info

Concept Stone

INTERIORS STONE

MOSAICI E PEZZI SPECIALI
SPECIAL TRIMS
PIECES SPECIALES
SONDERSTÜCKE

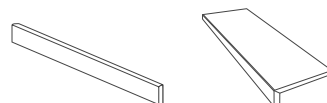

**BATTISCOPA
MOLATO**

8x80
10

BIANCO

GML54100

GRIGIO

GML54103

ANTRACITE

GML54105

NERO

GML54106

BEIGE CHIARO

GML54101

SABBIA

GML54102

BRUNO MEDIO

GML54104

GRADONE

80x32x4
1

G0054480

G0054483

G0054485

G0054486

G0054481

G0054482

G0054484

PRICE LIST €

PZ 12,90

PZ 132,50

I dati relativi a imballaggi e pesi possono subire delle variazioni . Informations and details related to packaging and weight are subject to change. Les données concernant emballage et poids sont sujettes à variations . Dieangaben über verpackungen und gewichte sind nicht bindend

CARATTERISTICHE . CHARACTERISTICS . CARACTERISTIQUES . HAUPTEIGENSCHAFTEN

Classificazione secondo le norme EN 14411/G Bia

Classification in the accordance with . classification selon les normes . Einstufung nach den Normen

Gres porcellanato pressato a secco . Dry-pressed ceramic tiles . Fine porcelaine . Stonewareporcelain

8,5MM: 80X180 (32"X72") NAT. | 26,5X180 (10"X72") NAT. | 80X80 (32"X32") NAT., R11 | 40X80 (16"X32") NAT., R11
20MM: 80X80 (32"X32") R11

PROPRIETÀ FISICO-CHIMICHE PHYSICAL-CHEMICAL PROPERTIES	NORMA NORM	VALORE PRESCRITTO DALLE NORME VALUE PRESCRIBED FROM THE NORMS	VALORE GARDENIA* GARDENIA VALUE*
	B.C.R.A. C.A.	μ 0,19 SCIVOLOSITÀ PERICOLOSA . DANGEROUSLY SLIPPERY 0,20 < μ < 0,39 SCIVOLOSITÀ ECCESSIVA . EXCESSIVELY SLIPPERY	> 0,40
	B.C.R.A. G.B.	0,40 < μ < 0,74 ATTRITO SODDISFACENTE . SATISFACTORY GRIP μ 0,75 ATTRITO ECCELLENTE . EXCELLENT GRIP	> 0,40
RESISTENZA ALLO SCIVOLAMENTO . SLIP RESISTANCE	ASTM C 1028 (S.C.O.F.)	SLIP RESISTANT (> 0,60)	> 0,60 DRY > 0,60 WET
	DIN EN 16165 B	IN FUNZIONE DELL'AMBIENTE O DELLA ZONA DI LAVORO BASING ON THE ENVIRONMENT OR THE WORKING AREA	R10 (NAT.) - R11 (R11)
	DIN EN 16165 A	-	A+B (NAT.) - A+B (R11)
	ANSI A 137-1:2012	≥ 0,42	> 0,42

*importante: rispondenti ai valori medi di produzione - nessun riferimento al lotto fornito. - Important: responding to average production values - no reference to the batch supplied

SHADE VARIATION VARIAZIONE CROMATICA

V2
lieve variazione
light variation



V3*
moderata variazione
moderate variation

*Antracite



Wall
Beige chiaro 40x80

About us

Style
Group
Technology
6mm
Collections

Interiors

MARBLE
La Marmoteca

STONE
La Geoteca
Pietra Viva
Origini
Concept Stone
Burlington Stone

RESIN
I Pigmenti

SOLID COLORS
Chrome

METAL
Oxide

CONCRETE
Make

WOOD
Just Code
Just Nature
Just Color

Decor

Boiserie
Gioia

Technical Info

Technical info

Outdoor

STONE
La Geoteca
Pietra Viva
Origini
Fusion
Burlington Stone
Concept Stone
Antiqua
Soul
Suisse

RESIN
I Pigmenti

METAL
Oxide

CONCRETE
Make
Native
Mesh Up

WOOD
Just Code
Timber
Woodland

INDEX

Burlington Stone

GRES FINE PORCELLANATO A MASSA COLORATA
COLORBODY FINE PORCELAIN STONEWARE



2 SUPERFICI . SURFACES

Natural R10
Outdoor R11



5 FORMATI . SIZES

80X180 . 32"X72"
80X80 . 32"X32"
100X100 . 40"X40"
60X120 . 24"X48"
60X60 . 24"X24"



2 SPESSORI . THICKNESSES

8,5MM - 20MM



Pearl



Rock

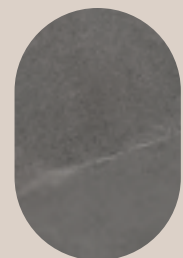

Graphite



Cream



Complete
collection



Wall
Pearl 80x180 . Rock 80x180

About us

Style
Group
Technology
6mm
Collections

Outdoor

STONE
La Geoteca
Pietra Viva
Origini
Fusion
Burlington Stone
Concept Stone
Antiqua
Soul
Suisse

Interiors

MARBLE
La Marmoteca

STONE
La Geoteca
Pietra Viva
Origini
Concept Stone
Burlington Stone

RESIN
I Pigmenti

SOLID COLORS
Chrome

METAL
Oxide

CONCRETE
Make

WOOD
Just Code
Just Nature
Just Color

RESIN
I Pigmenti

METAL
Oxide

CONCRETE
Make

Native
Mesh Up

WOOD
Just Code

Timber
Woodland

Decor

Boiserie
Gioia

Technical Info

Technical info

INDEX

Burlington Stone

INTERIORS STONE

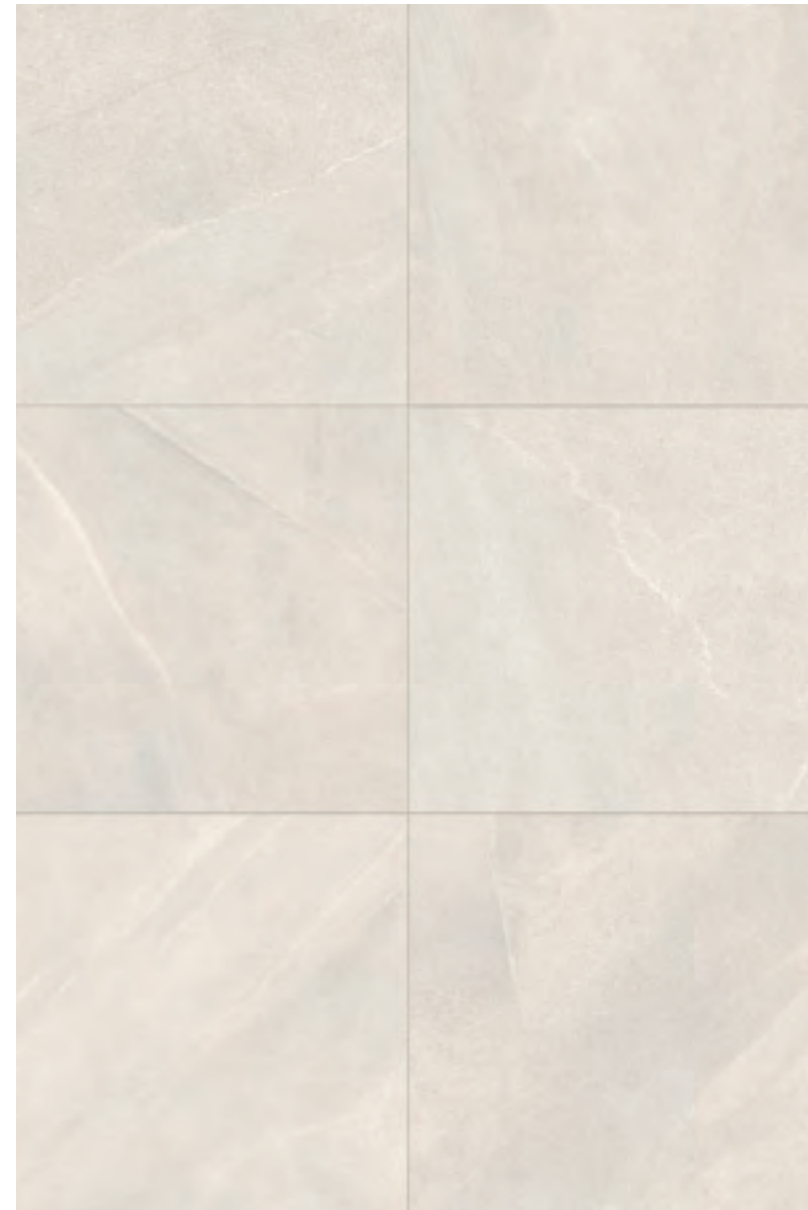

PEARL



ROCK



GRAPHITE



CREAM

	100x100	80x180	80x80	60x60	60x120	60x120 R11
PEARL	G0055510	G0055410	G0055300	G0055450	G0055430	G0055440
ROCK	G0055512	G0055412	G0055302	G0055452	G0055432	G0055442
PRICE LIST €	F 62,50	F 75,90	F 49,50	F 44,50	F 56,50	F 58,50

	100x100	80x80	60x60	60x120	60x120 R11
GRAPHITE	G0055513	G0055303	G0055453	G0055433	G0055443
CREAM	G0055511	G0055301	G0055451	G0055431	G0055441
PRICE LIST €	F 62,50	F 49,50	F 44,50	F 56,50	F 58,50

About us

Style
Group
Technology
6mm
Collections

Interiors

MARBLE
La Marmoteca

STONE
La Geoteca
Pietra Viva
Origini
Concept Stone
Burlington Stone

RESIN
I Pigmenti

SOLID COLORS
Chrome

METAL
Oxide

CONCRETE
Make

WOOD
Just Code
Just Nature
Just Color

Decor

Boiserie
Gioia

Outdoor

STONE
La Geoteca
Pietra Viva
Origini
Fusion
Burlington Stone
Concept Stone
Antiqua
Soul
Suisse

RESIN
I Pigmenti

METAL
Oxide

CONCRETE
Make
Native
Mesh Up

WOOD
Just Code
Timber
Woodland

Technical Info

Technical info

INDEX

Burlington Stone

INTERIORS STONE

MOSAICI E PEZZI SPECIALI
SPECIAL TRIMS
PIECES SPECIALES
SONDERSTÜCKE

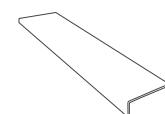
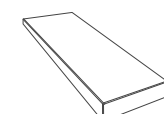
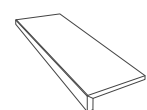
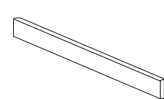

**BATTISCOPA
MOLATO**
8x80
10

GML55300

PEARL

ROCK

GML55302

GRAPHITE

GML55303

CREAM

GML55301

PRICE LIST €

PZ 12,90

GRADONE TOP
120x32x4
1

G0055460

G0055462

G0055463

G0055461

PZ 202,50

GRADONE ANGOLARE
120x32x4
1

G0055470 DX
G0055480 SX

G0055472 DX
G0055482 SX

G0055473 DX
G0055483 SX

G0055471 DX
G0055481 SX

PZ 232,90

ELEMENTO A L
120x32x4 R11
1

G0055490

G0055492

G0055493

G0055491

PZ 146,90

I dati relativi a imballaggi e pesi possono subire delle variazioni . Informations and details related to packaging and weight are subject to change. Les données concernant emballage et poids sont sujettes à variations . Dieangaben über verpackungen und gewichte sind nicht bindend

CARATTERISTICHE . CHARACTERISTICS . CARACTERISTIQUES . HAUPTZEIGENSCHAFTEN

Classificazione secondo le norme EN 14411/G Bia

Classification in the accordance with . classification selon les normes . Einstufung nach den Normen

Gres porcellanato tutta massa . Full body porcelain

SHADE VARIATION VARIAZIONE CROMATICA

V2
lieve variazione
light variation



8,5MM: 100X100 (40"X40") NAT | 80X80 (32"X32") NAT | 40X80 (16"X32") NAT | 60X120 (24"X48") NAT, R11 | 60X60 (24"X24") NAT | 26,5X180 (10"X72") NAT | 80X180 (32"X72") NAT

PROPRIETÀ FISICO-CHIMICHE PHYSICAL-CHEMICAL PROPERTIES	NORMA NORM	VALORE PRESCRITTO DALLE NORME VALUE PRESCRIBED FROM THE NORMS	VALORE GARDENIA* GARDENIA VALUE*
	B.C.R.A. C.A	μ 0,19 SCIIVOLOSITÀ PERICOLOSA . DANGEROUSLY SLIPPERY 0,20 < μ < 0,39 SCIIVOLOSITÀ ECCESSIVA . EXCESSIVELY SLIPPERY	> 0,40
	B.C.R.A. G.B.	0,40 < μ < 0,74 ATTRITO SODDISFACENTE . SATISFACTORY GRIP μ 0,75 ATTRITO ECCELLENTE . EXCELLENT GRIP	> 0,40
	ASTM C 1028 (S.C.O.F.)	SLIP RESISTANT (> 0,60)	> 0,60 DRY > 0,60 WET
RESISTENZA ALLO SCIVOLAMENTO . SLIP RESISTANCE	DIN EN 16165 B	IN FUNZIONE DELL'AMBIENTE O DELLA ZONA DI LAVORO BASING ON THE ENVIRONMENT OR THE WORKING AREA	R10 (NAT.) - R11 (R11)
	DIN EN 16165 A	-	B (NAT.) - B (R11)
	ANSI A 137-1:2012	> 0,42	> 0,42



Wall
Rock 60x120

About us

Style
Group
Technology
6mm
Collections

Interiors

MARBLE
La Marmoteca

STONE
La Geoteca
Pietra Viva
Origini
Concept Stone
Burlington Stone

RESIN
I Pigmenti

SOLID COLORS
Chrome

METAL
Oxide

CONCRETE
Make

WOOD
Just Code
Just Nature
Just Color

Decor

Boiserie
Gioia

Technical Info

Technical info

Outdoor

STONE
La Geoteca
Pietra Viva
Origini
Fusion
Burlington Stone
Concept Stone
Antiqua
Soul
Suisse

RESIN
I Pigmenti

METAL
Oxide

CONCRETE
Make
Native
Mesh Up

WOOD
Just Code
Timber
Woodland

INDEX

I Pigmenti

GRES FINE PORCELLANATO
FINE PORCELAIN STONEWARE



2 SUPERFICI . SURFACES

Natural
Outdoor R11



8 FORMATI . SIZES

120X280 . 48"X110"
120X120 . 48"X48"
60X120 . 24"X48"
60X60 . 24"X24"
20X120 . 8"X48"
5X120 . 2"X48"
10X60 . 4"X24"
30X30 . 12"X12"



3 SPESSORI . THICKNESSES

6MM - 8,5MM



TECNOLOGIA . TECHNOLOGY

3D tech



Milk



Ash



Concrete



Mud



Clay



Cream



Sand



Bark



Mou



Cotto

About us

Style
Group
Technology
6mm
Collections

Outdoor

STONE
La Geoteca
Pietra Viva
Origini
Fusion
Burlington Stone
Concept Stone
Antiqua
Soul
Suisse

Interiors

MARBLE
La Marmoteca

STONE
La Geoteca
Pietra Viva
Origini
Concept Stone
Burlington Stone

RESIN
I Pigmenti

SOLID COLORS
Chrome

METAL
Oxide

CONCRETE
Make

WOOD
Just Code
Just Nature
Just Color

RESIN
I Pigmenti

METAL
Oxide

CONCRETE
Make

NATIVE
Mesh Up

WOOD
Just Code
Timber
Woodland

Decor

Boiserie
Gioia

Technical
Info

Technical info

INDEX



Complete
collection



Best box
gallery



About us

- Style
- Group
- Technology
- 6mm
- Collections

Interiors

MARBLE

- La Marmoteca

STONE

- La Geoteca
- Pietra Viva
- Origini
- Concept Stone
- Burlington Stone

RESIN

- I Pigmenti

SOLID COLORS

- Chrome

METAL

- Oxide

CONCRETE

- Make

WOOD

- Just Code
- Just Nature
- Just Color

Decor

- Boiserie
- Gioia

Technical Info

Technical info

Outdoor

STONE

- La Geoteca
- Pietra Viva
- Origini
- Fusion

Burlington Stone

Concept Stone

Antiqua

Soul

Suisse

RESIN

I Pigmenti

METAL

Oxide

CONCRETE

Make

Native

Mesh Up

WOOD

Just Code

Timber

Woodland

INDEX

Wall
Crocini 60x120

Floor
La Geoteca Ceppo di Gre 120x120

Furniture
Milk 120x280



Wall
Mou 120x280
Mou 5x120

Floor
Cream 10x60

About us

Style
Group
Technology
6mm
Collections

Interiors

MARBLE
La Marmoteca

STONE
La Geoteca
Pietra Viva
Origini
Concept Stone
Burlington Stone

RESIN
I Pigmenti

SOLID COLORS
Chrome

METAL
Oxide

CONCRETE
Make

WOOD
Just Code
Just Nature
Just Color

Decor

Boiserie
Gioia

Technical Info

Technical info

Outdoor

STONE
La Geoteca
Pietra Viva
Origini
Fusion
Burlington Stone
Concept Stone
Antiqua
Soul
Suisse

RESIN
I Pigmenti

METAL
Oxide

CONCRETE
Make
Native
Mesh Up

WOOD
Just Code
Timber
Woodland

INDEX

I Pigmenti

INTERIORS RESIN



Floor
Ash 120x120
Ash 120x120 R11



Wall
Mud 120x280
Mud 20x120
Mud 10x60

Floor
Mud 60x120

Furniture
La Geoteca Travertino Ivory Cross 120x280

About us

Style
Group
Technology
6mm
Collections

Interiors

MARBLE
La Marmoteca

STONE
La Geoteca
Pietra Viva
Origini
Concept Stone
Burlington Stone

RESIN
I Pigmenti

SOLID COLORS
Chrome

METAL
Oxide

CONCRETE
Make

WOOD
Just Code
Just Nature
Just Color

Decor

Boiserie
Gioia

Technical Info

Technical info

Outdoor

STONE
La Geoteca
Pietra Viva
Origini
Fusion

Burlington Stone
Concept Stone

Antiqua
Soul
Suisse

RESIN
I Pigmenti

METAL
Oxide

CONCRETE
Make
Native
Mesh Up

WOOD
Just Code
Timber
Woodland

INDEX



Wall
Ash 120x280

Floor
Concrete 120x120
Ash 10x60
Milk 10x60

About us

- Style
- Group
- Technology
- 6mm
- Collections

Interiors

- MARBLE**
- La Marmoteca
- STONE**
- La Geoteca
- Pietra Viva
- Origini
- Concept Stone
- Burlington Stone
- RESIN**
- I Pigmenti
- SOLID COLORS**
- Chrome
- METAL**
- Oxide
- CONCRETE**
- Make
- WOOD**
- Just Code
- Just Nature
- Just Color

Decor

- Boiserie
- Gioia

Technical Info

Technical info

Outdoor

- STONE**
- La Geoteca
- Pietra Viva
- Origini
- Fusion
- Burlington Stone
- Concept Stone
- Antiqua
- Soul
- Suisse
- RESIN**
- I Pigmenti
- METAL**
- Oxide
- CONCRETE**
- Make
- Native
- Mesh Up
- WOOD**
- Just Code
- Timber
- Woodland

INDEX

I Pigmenti

INTERIORS RESIN



MILK



ASH

	120x280 6MM	120x120 8,5MM	60x120 8,5MM	60x60 8,5MM	10X60 8,5MM	5X120 8,5MM	20X120 8,5MM	30X30 8,5MM	120X120 8,5MM R11	60X120 8,5MM R11
MILK	0017003	0016962	0016428	0016448	0016458	0017087	0016438	0016604		
ASH	0016997	0016961	0016429	0016449	0016459	0017088	0016439	0016605	0017464	0017144
PRICE LIST €	F 110,90	F 86,50	F 67,50	F 61,50	F 89,90	F 110,90	F 75,90	F 89,90	F 69,50	F 89,50

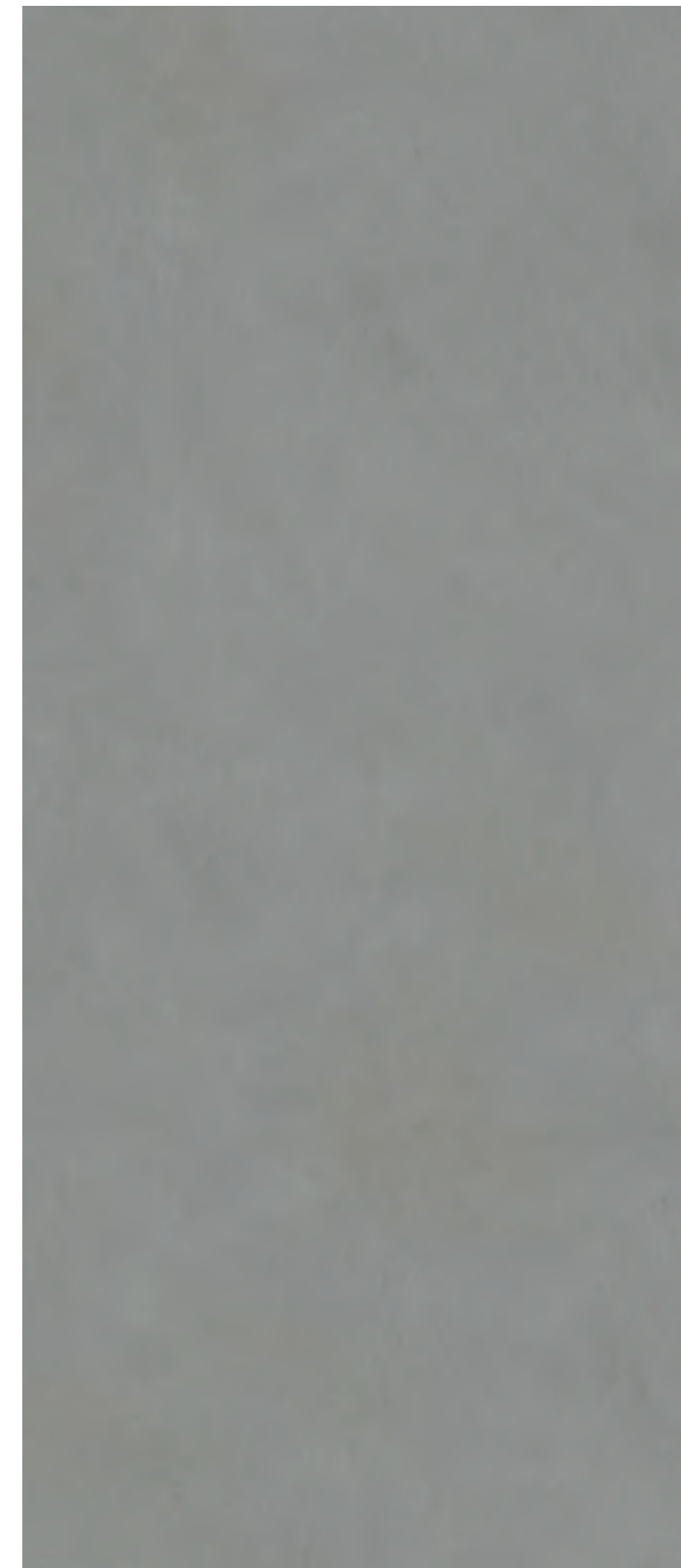

CONCRETE



MUD

	120x280 6MM	120x120 8,5MM	60x120 8,5MM	60x60 8,5MM	10X60 8,5MM	5X120 8,5MM	20X120 8,5MM	30X30 8,5MM
CONCRETE	0017000	0016974	0016437	0016457	0016467	0017104	0016447	0016613
MUD	0017005	0016972	0016436	0016456	0016466	0017103	0016446	0016612
PRICE LIST €	F 110,90	F 86,50	F 67,50	F 61,50	F 89,90	F 110,90	F 75,90	F 89,90

About us

Style
Group
Technology
6mm
Collections

Interiors

MARBLE
La Marmoteca

STONE
La Geoteca
Pietra Viva
Origini
Concept Stone
Burlington Stone

RESIN
I Pigmenti

SOLID COLORS
Chrome

METAL
Oxide

CONCRETE
Make

WOOD
Just Code
Just Nature
Just Color

Decor

Boiserie
Gioia

Technical Info

Technical info

Outdoor

STONE
La Geoteca
Pietra Viva
Origini
Fusion
Burlington Stone
Concept Stone
Antiqua
Soul
Suisse

RESIN
I Pigmenti

METAL
Oxide

CONCRETE
Make
Native
Mesh Up

WOOD
Just Code
Timber
Woodland

INDEX

I Pigmenti

INTERIORS RESIN



CREAM



SAND

	120x280 6MM	120x120 8,5MM	60x120 8,5MM	60x60 8,5MM	10X60 8,5MM	5X120 8,5MM	20X120 8,5MM	30X30 8,5MM	120X120 8,5MM R11	60X120 8,5MM R11
CREAM	0017002	0016975	0016433	0016453	0016463	0017100	0016443	0016609	0017466	0017146
SAND	0017006	0016963	0016430	0016450	0016460	0017089	0016440	0016606	0017465	0017145
PRICE LIST €	F 110,90	F 86,50	F 67,50	F 61,50	F 89,90	F 110,90	F 75,90	F 89,90	F 69,50	F 89,50



BARK



MOU

	120x280 6MM	120x120 8,5MM	60x120 8,5MM	60x60 8,5MM	10X60 8,5MM	5X120 8,5MM	20X120 8,5MM	30X30 8,5MM
BARK	0016998	0016970	0016432	0016452	0016462	0017099	0016442	0016608
MOU	0017004	0016973	0016435	0016455	0016465	0017102	0016445	0016611
PRICE LIST €	F 110,90	F 86,50	F 67,50	F 61,50	F 89,90	F 110,90	F 75,90	F 89,90

About us

- Style
- Group
- Technology
- 6mm
- Collections

Interiors

- MARBLE**
- La Marmoteca
- STONE**
- La Geoteca
- Pietra Viva
- Origini
- Concept Stone
- Burlington Stone

- RESIN**
- I Pigmenti

- SOLID COLORS**
- Chrome

- METAL**
- Oxide

- CONCRETE**
- Make

- WOOD**
- Just Code
- Just Nature
- Just Color

Decor

- Boiserie
- Gioia

Technical Info

Technical info

Outdoor

- STONE**
- La Geoteca
- Pietra Viva
- Origini
- Fusion
- Burlington Stone
- Concept Stone
- Antiqua
- Soul
- Suisse

- RESIN**
- I Pigmenti

- METAL**
- Oxide

- CONCRETE**
- Make
- Native
- Mesh Up

- WOOD**
- Just Code
- Timber
- Woodland

INDEX

I Pigmenti



COTTO



CLAY

MOSAICO CONFETTI 29,3X33,3 PZ 46.50

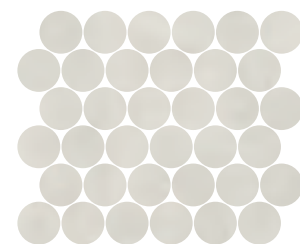

MILK NAT RETT
0017597

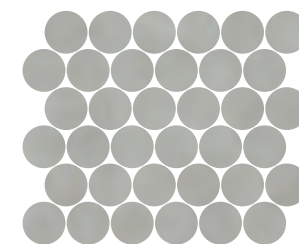

ASH NAT RETT
0017598

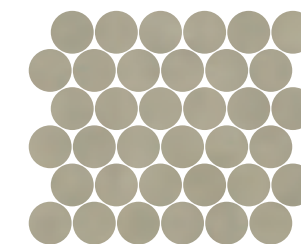

MUD NAT RETT
0017605

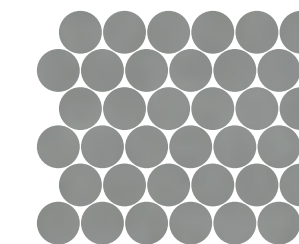

CONCRETE NAT RETT
0017606

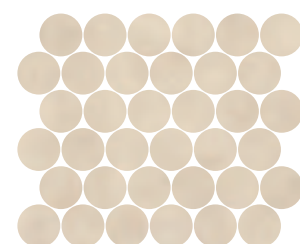

SAND NAT RETT
0017599

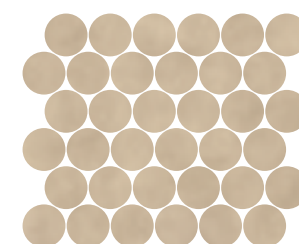

CREAM NAT RETT
00017602

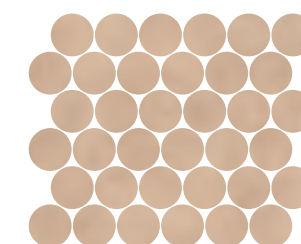

MOSAICO
CLAY NAT RETT
0017600

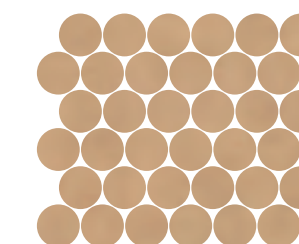

MOU NAT RETT
0017604

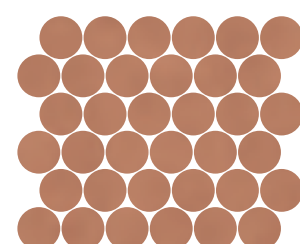

COTTO NAT RETT
0017603

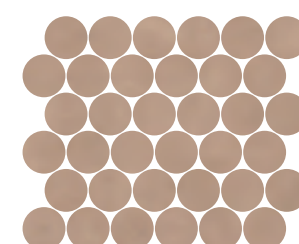

BARK NAT RETT
0017601

INTERIORS RESIN

About us

Style
Group
Technology
6mm
Collections

Interiors

MARBLE
La Marmoteca

STONE
La Geoteca
Pietra Viva
Origini
Concept Stone
Burlington Stone

RESIN
I Pigmenti

SOLID COLORS
Chrome

METAL
Oxide

CONCRETE
Make

WOOD
Just Code
Just Nature
Just Color

Decor

Boiserie
Gioia

Technical Info

Technical info

Outdoor

STONE
La Geoteca
Pietra Viva
Origini
Fusion
Burlington Stone
Concept Stone
Antiqua
Soul
Suisse

RESIN
I Pigmenti

METAL
Oxide

CONCRETE
Make
Native
Mesh Up

WOOD
Just Code

Timber
Woodland

INDEX

	120x280 6MM	120x120 8,5MM	60x120 8,5MM	60x60 8,5MM	10X60 8,5MM	5X120 8,5MM	20X120 8,5MM	30X30 8,5MM
BARK	0017001	0016969	0016434	0016454	0016464	0017101	0016444	0016610
MOU	0016999	0016964	0016431	0016451	0016461	0017090	0016441	0016607
PRICE LIST €	F 110,90	F 86,50	F 67,50	F 61,50	F 89,90	F 110,90	F 75,90	F 89,90

I Pigmenti

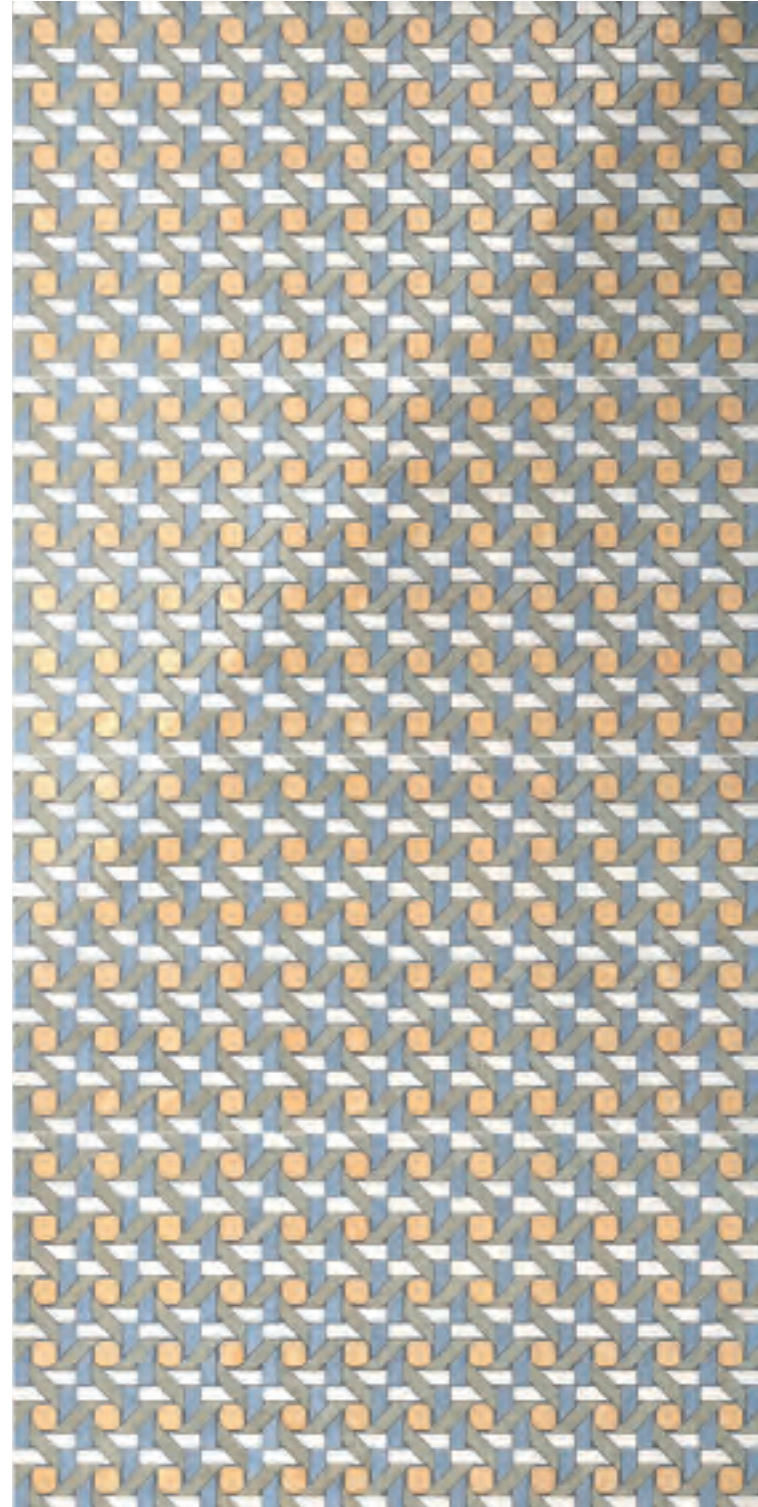

RATTAN

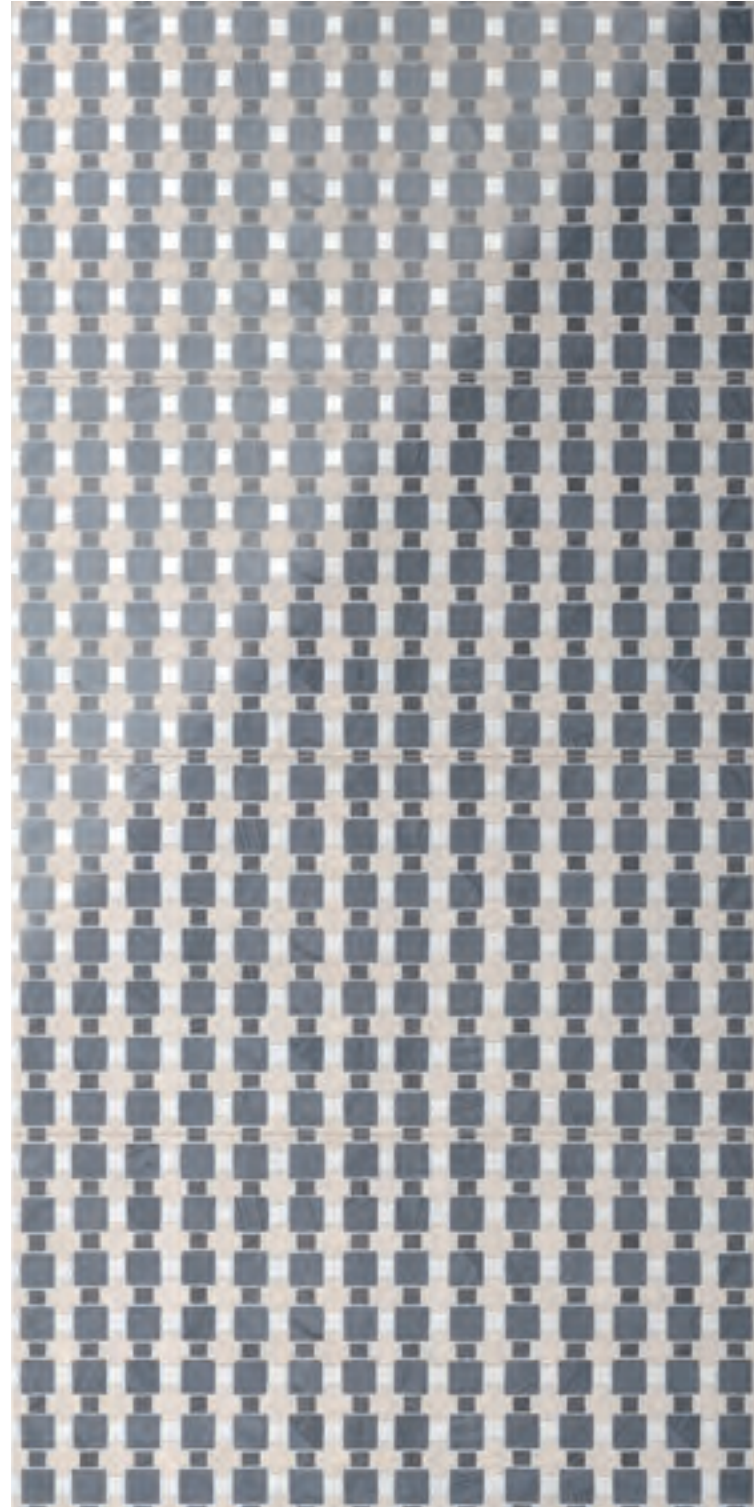

CROCINI

	60x120 8,5MM 3DTECH
RATTAN	0014512
CROCINI	0014514
PRICE LIST €	F 110,50

INTERIORS RESIN



PILLOLE

	60x120 8,5MM 3DTECH
PILLOLE	0014511
PRICE LIST €	F 110,50

About us

Style
Group
Technology
6mm
Collections

Interiors

MARBLE

La Marmoteca

STONE

La Geoteca
Pietra Viva
Origini
Concept Stone
Burlington Stone

RESIN

I Pigmenti

SOLID COLORS

Chrome

METAL

Oxide

CONCRETE

Make

WOOD

Just Code
Just Nature
Just Color

Decor

Boiserie
Gioia

Technical Info

Technical info

Outdoor

STONE

La Geoteca
Pietra Viva
Origini
Fusion

Burlington Stone

Concept Stone

Antiqua

Soul

Suisse

RESIN

I Pigmenti

METAL

Oxide

CONCRETE

Make

Native

Mesh Up

WOOD

Just Code

Timber

Woodland

INDEX



Wall
Pillole 60X120

Floor
Cotto 120x120

I Pigmenti

INTERIORS RESIN

MOSAICI E PEZZI SPECIALI
SPECIAL TRIMS
PIECES SPECIALES
SONDERSTÜCKE

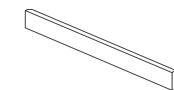

BATTISCOPA 5,5x120

Nat.8,5mm
☞10

MILK	0017446
ASH	0017447
SAND	0017448
CLAY	0017449
BARK	0017450
CREAM	0017451
COTTO	0017452
MOU	0017453
MUD	0017454
CONCRETE	0017455
PRICE LIST €	PZ 21,50

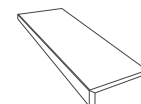

GRADONE TOP 32x120x4,5

Nat.8,5 mm
☞10

0017467	
0017468	
0017469	
0017470	
0017471	
0017472	
0017473	
0017474	
0017475	
0017476	
PRICE LIST €	PZ 202,50

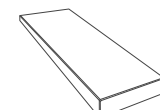

ANGOLARE TOP 32x120x4,5

Nat.8,5 mm
☞1

0017487 DX	
0017477 SX	
0017488 DX	
0017478 SX	
0017489 DX	
0017479 SX	
0017490 DX	
0017480 SX	
0017491 DX	
0017481 SX	
0017492 DX	
0017482 SX	
0017493 DX	
0017483 SX	
0017494 DX	
0017484 SX	
0017495 DX	
0017485 SX	
0017496 DX	
0017486 SX	
PRICE LIST €	PZ 232,90

CARATTERISTICHE . CHARACTERISTICS . CARACTERISTIQUES . HAUPTEIGENSCHAFTEN

Superficie nat: classificazione secondo norme uni en 14411 (iso 13006) allegato g-gruppo bla ugl
Nat surface: classification in accordance with uni en 14411 (iso 13006) annex g-group bla ugl

Gres porcellanato tutta massa. Full body porcelain. Fine porcelaine. Stonewareporcelain

6MM: 120X280 (48"X112") NAT, LUX | 120X120 (48"X48") NAT,LUX | 60X120 (24"X48") NAT,LUX

8,5MM: 120X120 (48"X48") NAT | 60X120 (24"X48") NAT, | 60X60 (24"X24") NAT, | 20X120 (8"X48") NAT
5X120 (2"X48") NAT | 10X60 (4"X24") NAT | 30X30 (12"X12") NAT

SHADE VARIATION VARIAZIONE CROMATICA

V2
Lieve variazione
Slight appearance



PROPRIETÀ FISICO-CHIMICHE PHYSICAL-CHEMICAL PROPERTIES	NORMA NORM	VALORE PRESCRITTO DALLE NORME VALUE PRESCRIBED FROM THE NORMS	VALORE GARDENIA* GARDENIA VALUE*
	B.C.R.A. C.A.	0,19 SCIVOLOSITÀ PERICOLOSA - DANGEROUSLY SLIPPERY 0,20 < < 0,39 SCIVOLOSITÀ ECCESSIVA - EXCESSIVELY SLIPPERY	> 0,40
	B.C.R.A. G.B.	0,40 < < 0,74 ATTRITO SODDISFACENTE - SATISFACTORY GRIP 0,75 ATTRITO ECCELLENTE - EXCELLENT GRIP	> 0,40
RESISTENZA ALLO SCIVOLAMENTO SLIP RESISTANCE	ASTM C 1028 (S.C.O.F.)	SLIP RESISTANT (> 0,60)	> 0,60 DRY > 0,60 WET
	DIN EN 16165 B	IN FUNZIONE DELL'AMBIENTE O DELLA ZONA DI LAVORO BASING ON THE ENVIRONMENT OR THE WORKING AREA	R10
	DIN EN 16165 A	-	A + B
	ANSI A 137-1:2012	≥ 0,42	> 0,42

About us

Style
Group
Technology
6mm
Collections

Interiors

MARBLE
La Marmoteca

STONE
La Geoteca
Pietra Viva
Origini
Concept Stone
Burlington Stone

RESIN
I Pigmenti

SOLID COLORS
Chrome

METAL
Oxide

CONCRETE
Make

WOOD
Just Code
Just Nature
Just Color

Decor

Boiserie
Gioia

Technical Info

Technical info

Outdoor

STONE
La Geoteca
Pietra Viva
Origini
Fusion
Burlington Stone
Concept Stone
Antiqua
Soul
Suisse

RESIN
I Pigmenti

METAL
Oxide

CONCRETE
Make
Native
Mesh Up

WOOD
Just Code
Timber
Woodland

INDEX

Chrome

GRES FINE PORCELLANATO A MASSA COLORATA
COLORBODY FINE PORCELAIN STONEWARE



3 SUPERFICI . SURFACES

Soft
Lux
Natural



3 FORMATI . SIZES

120X280 . 48"X110"
120X120 . 48"X48"
60X120 . 24"X48"



2 SPESSORI . THICKNESSES

6MM - 8,5MM



White



Black



Complete
collection



Wall
White Soft 120x280

Floor
La Marmoteca Grey Stone nat 120x120

About us

Style
Group
Technology
6mm
Collections

Outdoor

STONE
La Geoteca
Pietra Viva
Origini
Fusion
Burlington Stone
Concept Stone
Antiqua
Soul
Suisse

Interiors

MARBLE
La Marmoteca

STONE
La Geoteca
Pietra Viva
Origini
Concept Stone
Burlington Stone

RESIN
I Pigmenti

SOLID COLORS
Chrome

METAL
Oxide

CONCRETE
Make

WOOD
Just Code
Just Nature
Just Color

RESIN
I Pigmenti

METAL
Oxide

CONCRETE
Make
Native
Mesh Up

WOOD
Just Code
Timber
Woodland

Decor

Boiserie
Gioia

Technical Info

Technical info

INDEX

Chrome

INTERIORS SOLID COLORS



BLACK

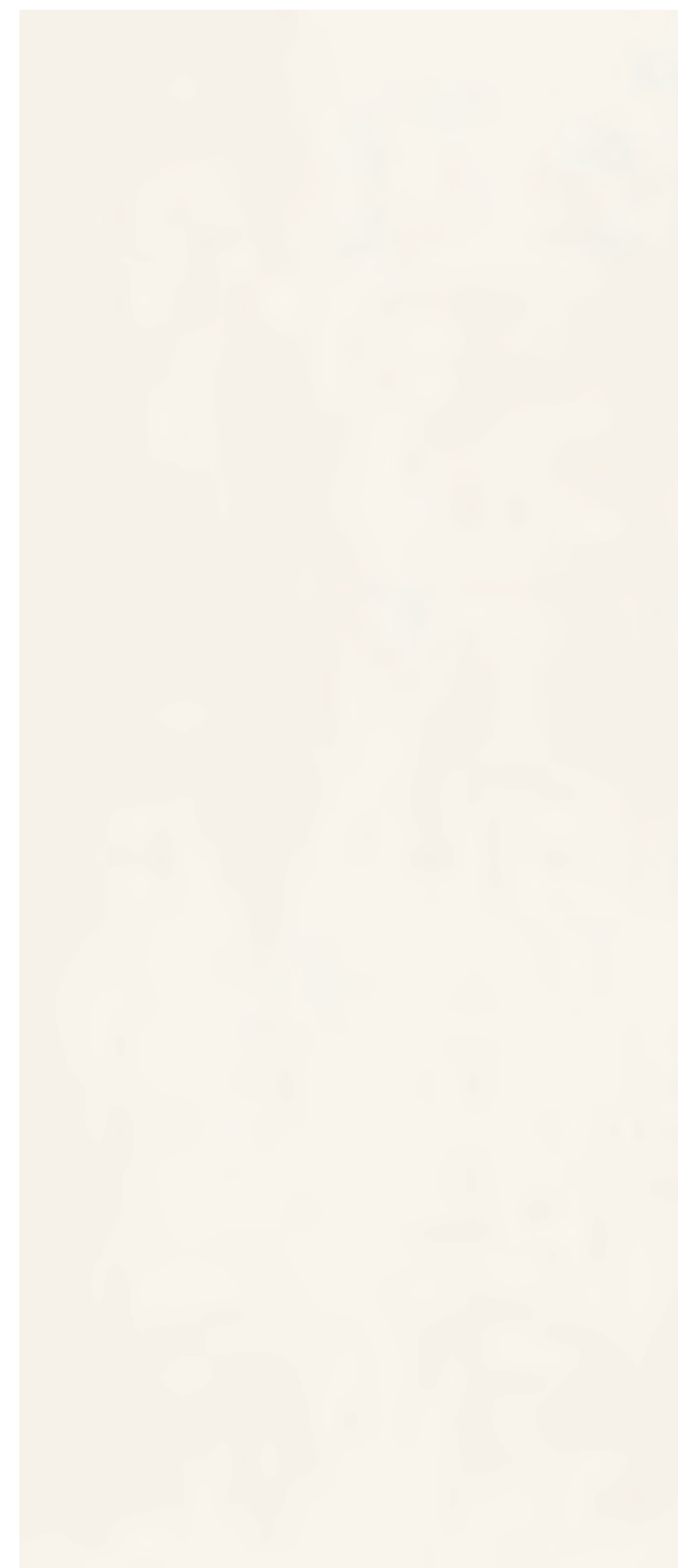

WHITE

	120x280 LUX 6MM	120x280 SOFT 6MM	120x120 NAT 8,5MM	120x120 LUX 8,5MM	60x120 NAT 8,5MM	60x120 LUX 8,5MM
WHITE	0008639	0008044	0013302	0013304	0013301	0013303
BLACK		0008638	0013808		0013809	
PRICE LIST €	F 136,90	F 116,50	F 90,50	F 118,5	F 69,90	F 90,50

MOSAICI E PEZZI SPECIALI
SPECIAL TRIMS
PIECES SPECIALES
SONDERSTÜCKE

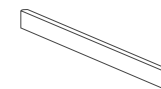

BATTISCOPA

	5,5x120 NAT RET 6	5,5x120 LUX RET 6
WHITE	0012512	0012513
BLACK	0013810	-
PRICE LIST €	PZ 12,90	PZ 15,50

I dati relativi a imballaggi e pesi possono subire delle variazioni . Informations and details related to packaging and weight are subject to change. Les données concernant emballage et poids sont sujettes à variations . Dieangaben über verpackungen und gewichte sind nicht bindend

CARATTERISTICHE .CHARACTERISTICS . CARACTERISTIQUES . HAUPTZEIGENSCHAFTEN

Classificazione secondo le norme EN 14411/G Bla

Classification in the accordance with . classification selon les normes . Einstufung nach den Normen

Gres porcellanato pressato a secco . Dry-pressed ceramic tiles . Fine porcelaine . Stonewareporcelain

6MM: 120X280 (48"X112") SOFT, LUX
8,5MM: 120X120 (48"X48") NAT,LUX | 60X120 (24"X48") NAT,LUX

PROPRIETÀ FISICO-CHIMICHE PHYSICAL-CHEMICAL PROPERTIES	NORMA NORM	VALORE PRESCRITTO DALLE NORME VALUE PRESCRIBED FROM THE NORMS	VALORE GARDENIA* GARDENIA VALUE*
LUNGHEZZA E LARGHEZZA DIMENSIONE MEDIA DI OGNI PIASTRELLA LENGTH AND WIDTH OF THE AVERAGE-SIZES TILE	UNI EN ISO 10545/2	± 0,5%	CONFORME ACCORDING
SPESSORE . THICKNESS	UNI EN ISO 10545/2	± 0,5%	CONFORME ACCORDING
RETTILINEARITÀ SPIGOLI . WARPAGES OF EDGES	UNI EN ISO 10545/2	± 0,5%	CONFORME ACCORDING
ORTOGONALITÀ . WEDGING	UNI EN ISO 10545/2	± 0,6%	CONFORME ACCORDING
PLANARITÀ . FLATNESS	UNI EN ISO 10545/2	± 0,5%	CONFORME ACCORDING
ASSORBIMENTO D'ACQUA . WATER ABSORPTION	UNI EN ISO 10545/3	E ≤ 0,5%	CONFORME ACCORDING
RESISTENZA ALLA FLESSIONE . BENDING STRENGTH	UNI EN ISO 10545/4	≥ 35 N/MM ²	CONFORME ACCORDING
FORZA DI ROTTURA . BREAKING STRENGTH	UNI EN ISO 10545/4	< 7,5 MM: ≥ 700 N	CONFORME ACCORDING
RESISTENZA ALL'ABRAZIONE SUPERFICIALE PER PIASTRELLE GL RESISTANCE TO SURFACE ABRASION OF GLAZED TILES	UNI EN ISO 10545/7	TEST METHOD AVAILABLE	CONFORME ACCORDING
RESISTENZA AGLI SBALZI TERMICI . THERMAL SHOCK RESISTANCE	UNI EN ISO 10545/9	RICHIESTA REQUIRED	RESISTE RESISTS
RESISTENZA AL GELO . FROST RESISTANCE	UNI EN ISO 10545/12	RICHIESTA REQUIRED	INGELIVO FROST PROOF
RESISTENZA ALL'ATTACCO CHIMICO . CHEMICAL RESISTANCE	UNI EN ISO 10545/13	MIN GB	CONFORME ACCORDING
RESISTENZA ALLE MACCHIE . RESISTANCE TO STAINING	UNI EN ISO 10545/14	TEST METHOD AVAILABLE	CONFORME ACCORDING

SHADE VARIATION VARIAZIONE CROMATICA

V1
aspetto uniforme
uniform appearance



About us

Style
Group
Technology
6mm
Collections

Interiors

MARBLE
La Marmoteca

STONE
La Geoteca
Pietra Viva
Origini
Concept Stone
Burlington Stone

RESIN
I Pigmenti

SOLID COLORS
Chrome

METAL
Oxide

CONCRETE
Make

WOOD
Just Code
Just Nature
Just Color

Decor

Boiserie
Gioia

Technical Info

Technical info

Outdoor

STONE
La Geoteca
Pietra Viva
Origini
Fusion
Burlington Stone
Concept Stone
Antiqua
Soul
Suisse

CONCRETE
Make
Native
Mesh Up

WOOD
Just Code
Timber
Woodland

INDEX

Oxide

GRES FINE PORCELLANATO A MASSA COLORATA
COLORBODY FINE PORCELAIN STONEWARE



2 SUPERFICI . SURFACES

Natural R10
Outdoor R11



4 FORMATI . SIZES

120X280 . 48"X110"
120X120 . 48"X48"
60X120 . 24"X48"
80X80 . 32"X32"



3 SPESSORI . THICKNESSES

6MM - 8,5MM - 20MM



TECNOLOGIA . TECHNOLOGY

3D tech



Aluminum



Brass



Steel



Green



Iron



Complete collection



Best box gallery



Wall
Brass 120x280

Floor
Aluminum 120x120

About us

Style
Group
Technology
6mm
Collections

Outdoor

STONE
La Geoteca
Pietra Viva
Origini
Fusion
Burlington Stone
Concept Stone
Antiqua
Soul
Suisse

Interiors

MARBLE
La Marmoteca

STONE
La Geoteca
Pietra Viva
Origini
Concept Stone
Burlington Stone

RESIN
I Pigmenti

SOLID COLORS
Chrome

METAL
Oxide

CONCRETE
Make

WOOD
Just Code
Just Nature
Just Color

RESIN
I Pigmenti

METAL
Oxide

CONCRETE
Make
Native
Mesh Up

WOOD
Just Code
Timber
Woodland

Decor

Boiserie
Gioia

Technical Info

Technical info

INDEX



Floor
Brass120x120

Wall
Brass 120x280 . La Marmoteca Antique Brown Soft 120x280

About us

Style
Group
Technology
6mm
Collections

Interiors

MARBLE
La Marmoteca

STONE
La Geoteca
Pietra Viva
Origini
Concept Stone
Burlington Stone

RESIN
I Pigmenti

SOLID COLORS
Chrome

METAL
Oxide

CONCRETE
Make

WOOD
Just Code
Just Nature
Just Color

Decor

Boiserie
Gioia

Technical Info

Technical info

Outdoor

STONE
La Geoteca
Pietra Viva
Origini
Fusion
Burlington Stone
Concept Stone
Antiqua
Soul
Suisse

RESIN
I Pigmenti

METAL
Oxide

CONCRETE
Make
Native
Mesh Up

WOOD
Just Code
Timber
Woodland

INDEX



Floor
Aluminium 120x120

Wall
Brass 120x280

Oxide

INTERIORS METAL



Floor
Green 120x120

Wall
Green 120x280 . La Marmoteca Calacatta Elegance Lux 120x280

About us

- Style
- Group
- Technology
- 6mm
- Collections

Interiors

MARBLE

- La Marmoteca

STONE

- La Geoteca
- Pietra Viva
- Origini
- Concept Stone
- Burlington Stone

RESIN

- I Pigmenti

SOLID COLORS

- Chrome

METAL

- Oxide

CONCRETE

- Make

WOOD

- Just Code
- Just Nature
- Just Color

Decor

- Boiserie
- Gioia

Technical Info

Technical info

Outdoor

STONE

- La Geoteca
- Pietra Viva
- Origini
- Fusion
- Burlington Stone
- Concept Stone

Antiqua

- Soul
- Suisse

RESIN

- I Pigmenti

METAL

- Oxide

CONCRETE

- Make
- Native
- Mesh Up

WOOD

- Just Code
- Timber
- Woodland

INDEX

Oxide

INTERIORS METAL



ALUMINUM



BRASS



GREEN

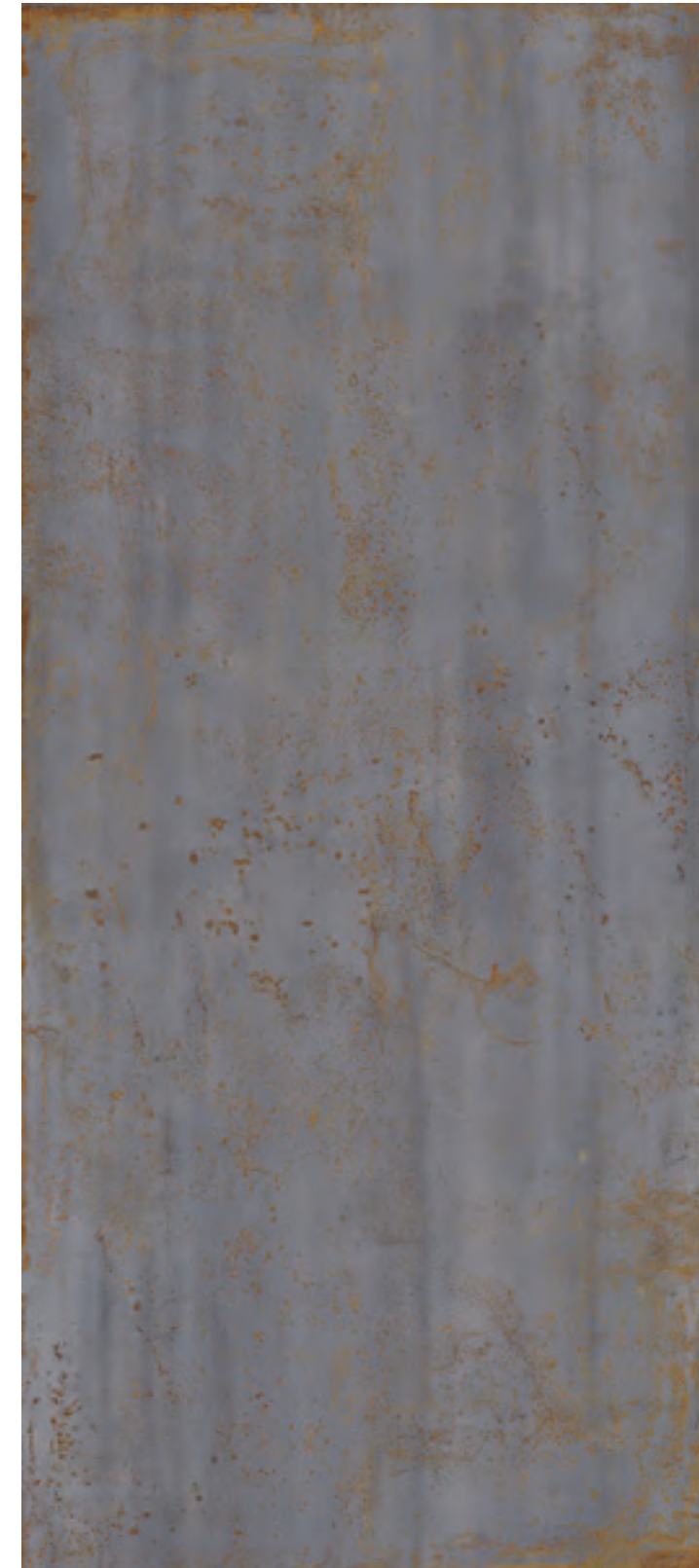

STEEL

	120x280 6MM	120x120	60x120	80x80	80x80 R11	80x80 R11 20MM
ALUMINUM	G69300	G69310	G69320	G0069330	G0069340	G0069350
BRASS	G69304	G69314	G69324	G0069334		
PRICE LIST €	F 94,90	F 76,50	F 58,50	F 54,90	F 56,90	F 84,50

	120x280 6MM	120x120	60x120	80x80	80x80 R11	80x80 R11 20MM
GREEN	G69303	G69313	G69323	G0069333	G0069343	G0069353
STEEL	G69301	G69311	G69321	G0069331		
PRICE LIST €	F 94,90	F 76,50	F 58,50	F 54,90	F 56,90	F 84,50

About us

Style
Group
Technology
6mm
Collections

Interiors

MARBLE
La Marmoteca

STONE
La Geoteca
Pietra Viva
Origini
Concept Stone
Burlington Stone

RESIN
I Pigmenti

SOLID COLORS
Chrome

METAL
Oxide

CONCRETE
Make

WOOD
Just Code
Just Nature
Just Color

Decor

Boiserie
Gioia

Technical Info

Technical info

Outdoor

STONE
La Geoteca
Pietra Viva
Origini
Fusion
Burlington Stone
Concept Stone
Antiqua
Soul
Suisse

RESIN
I Pigmenti

METAL
Oxide

CONCRETE
Make
Native
Mesh Up

WOOD
Just Code
Timber
Woodland

INDEX

Oxide



IRON

	120x280 6MM	120x120	60x120	80x80	80x80 R11	80x80 R11 20MM
IRON	G69302	G69312	G69322	G0069332	G0069342	G0069352
PRICE LIST €	F 94,90	F 76,50	F 58,50	F 54,90	F 54,50	F 84,50

INTERIORS METAL

DECORO 20x120 (mix 4 soggetti) F 75,50

WALL/FLOOR 3D tech



20x120
MIX GREEN
G69362

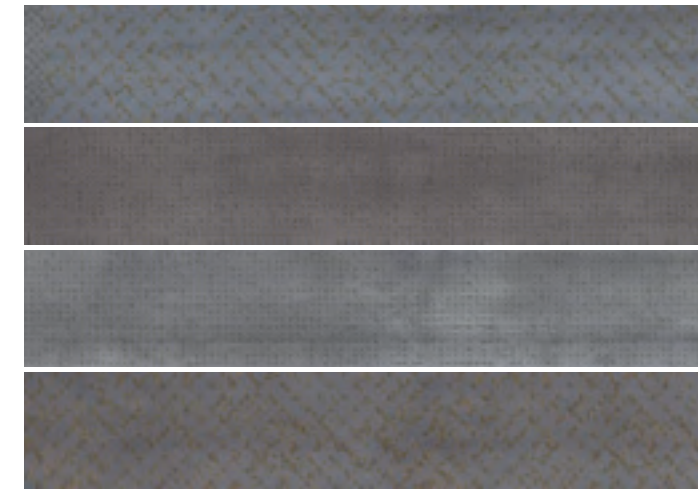

20x120
MIX IRON STEEL
G69360



20x120
MIX BRASS
G69361

About us

Style
Group
Technology
6mm
Collections

Interiors

MARBLE
La Marmoteca

STONE
La Geoteca
Pietra Viva
Origini
Concept Stone
Burlington Stone

RESIN
I Pigmenti

SOLID COLORS
Chrome

METAL
Oxide

CONCRETE
Make

WOOD
Just Code
Just Nature
Just Color

Decor

Boiserie
Gioia

Technical Info

Technical info

Outdoor

STONE
La Geoteca
Pietra Viva
Origini
Fusion
Burlington Stone
Concept Stone
Antiqua
Soul
Suisse

RESIN
I Pigmenti

METAL
Oxide

CONCRETE
Make
Native
Mesh Up

WOOD
Just Code
Timber
Woodland

INDEX

Oxide

INTERIORS METAL

MOSAICI E PEZZI SPECIALI
SPECIAL TRIMS
PIECES SPECIALES
SONDERSTÜCKE

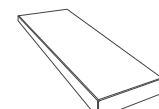
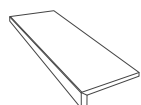
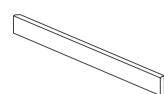

**BATTISCOPA
MOLATO**
5,5x120
📦 6

GML69320

ALUMINUM

STEEL

GML69321

IRON

GML69322

GREEN

GML69323

BRASS

GML69324

PRICE LIST €

PZ 21,50

GRADONE TOP

120x32x4

📦 1

G0069370

G0069371

G0069372

G0069373

G0069374

PZ 202,50

GRADONE ANGOLARE

120x32x4

📦 1

G0069380 SX

G0069390 DX

G0069381 SX

G0069391 DX

G0069382 SX

G0069392 DX

G0069383 SX

G0069393 DX

G0069384 SX

G0069394 DX

PZ 232,90

I dati relativi a imballaggi e pesi possono subire delle variazioni . Informations and details related to packaging and weight are subject to change. Les données concernant emballage et poids sont sujettes à variations . Dieangaben über verpackungen und gewichte sind nicht bindend

CARATTERISTICHE .CHARACTERISTICS . CARACTERISTIQUES . HAUPTEIGENSCHAFTEN

Classificazione secondo le norme EN 14411/G B1a

Classification in the accordance with . classification selon les normes . Einstufung nach den Normen

Gres porcellanato tutta massa . Full body porcelain

6MM: 120X280 (48"X112") NAT

8,5MM: 120X120 (48"X48") NAT | 60X120 (24"X48") NAT | 80X80 (32"X32") NAT, R11

20MM: 160X320 (64"X128") R11

SHADE VARIATION VARIAZIONE CROMATICA

V3
moderata variazione
moderate variation



PROPRIETÀ FISICO-CHIMICHE PHYSICAL-CHEMICAL PROPERTIES	NORMA NORM	VALORE PRESCRITTO DALLE NORME VALUE PRESCRIBED FROM THE NORMS	VALORE GARDENIA* GARDENIA VALUE*
	B.C.R.A. C.A.	μ 0,19 SCIVOLOSITÀ PERICOLOSA . DANGEROUSLY SLIPPERY 0,20 < μ < 0,39 SCIVOLOSITÀ ECCESSIVA . EXCESSIVELY SLIPPERY	> 0,40
	B.C.R.A. G.B.	0,40 < μ < 0,74 ATTRITO SODDISFACENTE . SATISFACTORY GRIP μ 0,75 ATTRITO ECCELLENTE . EXCELLENT GRIP	> 0,40
RESISTENZA ALLO SCIVOLAMENTO . SLIP RESISTANCE	ASTM C 1028 (S.C.O.F.)	SLIP RESISTANT (> 0,60)	> 0,60 DRY > 0,60 WET
	DIN EN 16165 B	IN FUNZIONE DELL'AMBIENTE O DELLA ZONA DI LAVORO BASING ON THE ENVIRONMENT OR THE WORKING AREA	R10 (NAT.) - R11 (R11)
	DIN EN 16165 A	-	B (NAT.) - C (R11)
	ANSI A 137-1:2012	≥ 0,42	> 0,42

*importante: rispondenti ai valori medi di produzione - nessun riferimento al lotto fornito. - Important: responding to average production values - no reference to the batch supplied



Floor
Iron 120x120

About us

Style

Group

Technology

6mm

Collections

Outdoor

STONE

La Geoteca

Pietra Viva

Origini

Fusion

Burlington Stone

Concept Stone

Antiqua

Soul

Suisse

RESIN

I Pigmenti

METAL

Oxide

CONCRETE

Make

Native

Mesh Up

WOOD

Just Code

Timber

Woodland

Interiors

MARBLE

La Marmoteca

STONE

La Geoteca

Pietra Viva

Origini

Concept Stone

Burlington Stone

RESIN

I Pigmenti

SOLID COLORS

Chrome

METAL

Oxide

CONCRETE

Make

WOOD

Just Code

Just Nature

Just Color

Decor

Boiserie

Gioia

Technical Info

Technical info

IND
D
EX

Make

GRES FINE PORCELLANATO TUTTA MASSA
FULLBODY FINE PORCELAIN STONEWARE



2 SUPERFICI . SURFACES

Natural R10
Outdoor R11



6 FORMATI . SIZES

100X100 . 40"X40"
80X80 . 32"X32"
40X80 . 16"X32"
60X120 . 24"X48"
60X60 . 24"X24"
30X60 . 12"X24



2 SPESSORI . THICKNESSES

8,5MM - 20MM

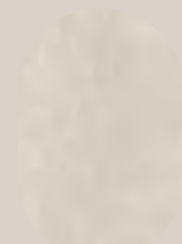

Bianco



Corda



Ash



Grigio



Antracite



Nero Corten



Complete
collection



Wall
Corda 100x100

Floor
Nero Corten 100x100

About us

Style
Group
Technology
6mm
Collections

Interiors

MARBLE
La Marmoteca

STONE
La Geoteca
Pietra Viva
Origini
Concept Stone
Burlington Stone

RESIN
I Pigmenti

SOLID COLORS
Chrome

METAL
Oxide

CONCRETE
Make

WOOD
Just Code
Just Nature
Just Color

Decor

Boiserie
Gioia

Technical Info

Technical info

Outdoor

STONE
La Geoteca
Pietra Viva
Origini
Fusion

Burlington Stone
Concept Stone

Antiqua
Soul
Suisse

RESIN
I Pigmenti

METAL
Oxide

CONCRETE
Make

Native
Mesh Up

WOOD
Just Code
Timber
Woodland

INDEX



Floor
Antracite Corten 80x80

Wall
Antracite Corten 80x80 . Antracite Corten 40x80

About us

Style
Group
Technology
6mm
Collections

Interiors

MARBLE
La Marmoteca

STONE
La Geoteca
Pietra Viva
Origini
Concept Stone
Burlington Stone

RESIN
I Pigmenti

SOLID COLORS
Chrome

METAL
Oxide

CONCRETE
Make

WOOD
Just Code
Just Nature
Just Color

Decor

Boiserie
Gioia

Technical Info

Technical info

Outdoor

STONE

La Geoteca
Pietra Viva
Origini
Fusion

Burlington Stone
Concept Stone

Antiqua
Soul
Suisse

RESIN

I Pigmenti

METAL

Oxide

CONCRETE

Make
Native
Mesh Up

WOOD

Just Code
Timber
Woodland

INDEX



ASH

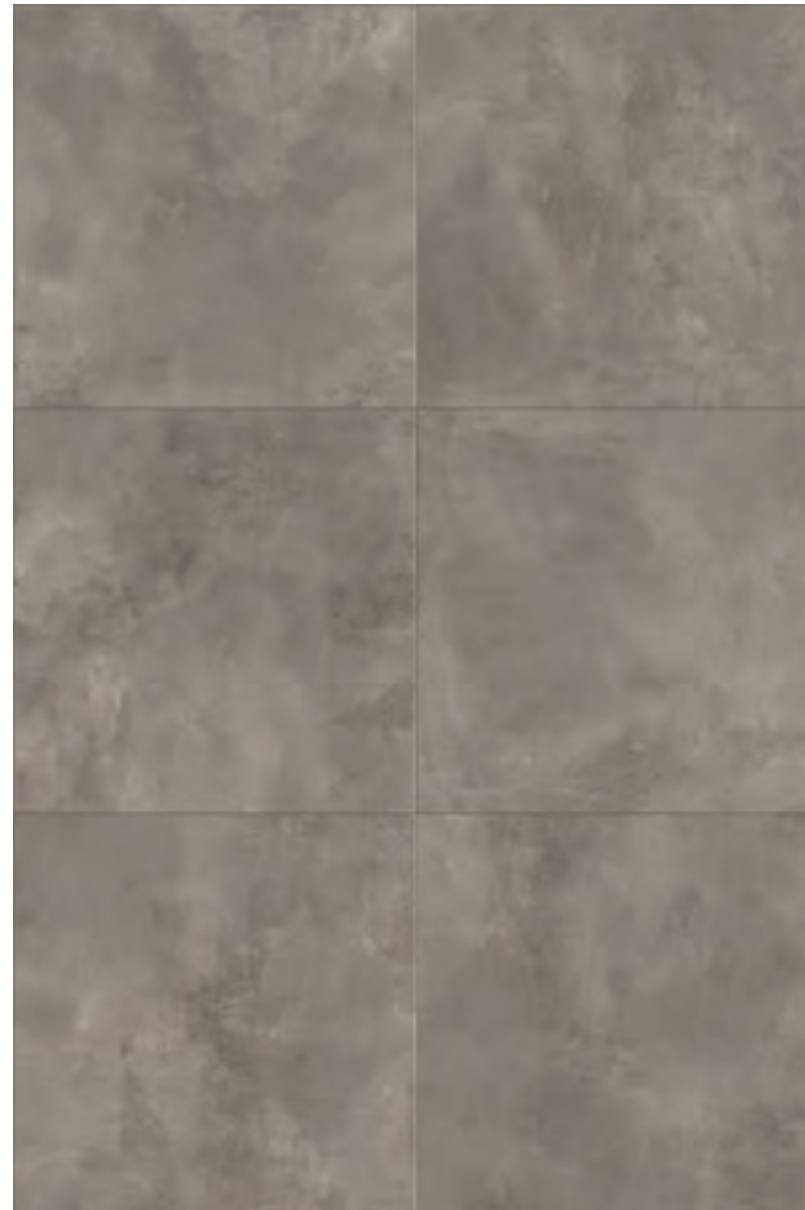

GRIGIO CORTEN



ANTRACITE CORTEN

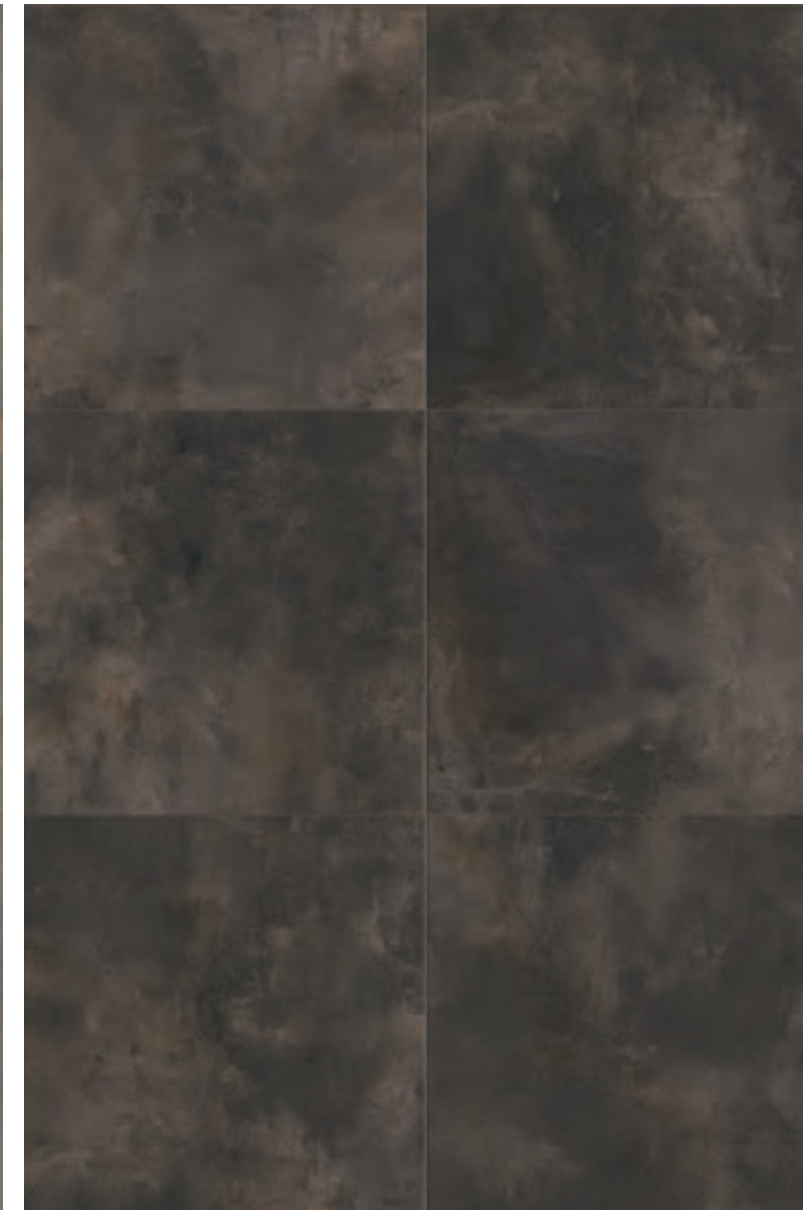

NERO CORTEN

	100x100	80x80	40x80	60x120	60x60	30x60	80x80	
							R11	R11 20MM
ASH	G0073042	G0073022	G0073012	G0073222	G0073212	G0073202	G0073102	G0073052
GRIGIO CORTEN	G0073045	G0073025	G0073015	G0073225	G0073215	G0073205	G0073105	G0073055
PRICE LIST €	F 62,50	F 49,50	F 48,50	F 56,50	F 44,50	F 44,50	F 52,50	F 84,50

	100x100	80x80	40x80	60x120	60x60	30x60	80x80	
							R11	R11 20MM
ANTRACITE CORTEN	G0073044	G0073024	G0073014	G0073224	G0073214	G0073204	G0073104	G0073054
NERO CORTEN	G0073043	G0073023	G0073013	G0073223	G0073213	G0073203		G0073053
PRICE LIST €	F 62,50	F 49,50	F 48,50	F 56,50	F 44,50	F 44,50	F 52,50	F 84,50

About us

- Style
- Group
- Technology
- 6mm
- Collections

Interiors

- MARBLE
- La Marmoteca

- STONE
- La Geoteca
- Pietra Viva
- Origini
- Concept Stone
- Burlington Stone

- RESIN
- I Pigmenti

- SOLID COLORS
- Chrome

- METAL
- Oxide

- CONCRETE
- Make

- WOOD
- Just Code
- Just Nature
- Just Color

Decor

- Boiserie
- Gioia

Outdoor

STONE

- La Geoteca
- Pietra Viva
- Origini
- Fusion
- Burlington Stone
- Concept Stone
- Antiqua
- Soul
- Suisse

RESIN

- I Pigmenti

METAL

- Oxide

CONCRETE

- Make
- Native
- Mesh Up

WOOD

- Just Code
- Timber
- Woodland

INDEX

Technical Info

Technical info

Make



BIANCO

CORDA

	100x100	80x80	40x80	60x120	60x60	30x60	80x80
BIANCO	G0073040	G0073020	G0073010	G0073220	G0073210	G0073200	
CORDA	G0073041	G0073021	G0073011	G0073221	G0073211	G0073201	G0073101
PRICE LIST €	F 62,50	F 49,50	F 48,50	F 56,50	F 44,50	F 44,50	F 52,50

INTERIORS CONCRETE

MOSAICI E PEZZI SPECIALI
SPECIAL TRIMS
PIECES SPECIALES
SONDERSTÜCKE

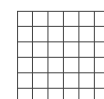

MOSAICO T36

33,3x33,3

BIANCO

G0073250

CORDA

G0073251

ASH

G0073252

NERO CORTEN

G0073253

ANTRACITE CORTEN

G0073254

GRIGIO CORTEN

G0073255

PRICE LIST €

PZ 19,50

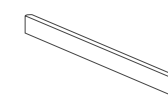

BATTISCOPA MOLATO

8x60

10

8x80

10

8x100

4

GML73210

GML73020

GML73040

GML73211

GML73021

GML73041

GML73212

GML73022

GML73042

GML73213

GML73023

GML73043

GML73214

GML73024

GML73044

GML73215

GML73025

GML73045

PZ 10,50

PZ 12,90

PZ 15,50

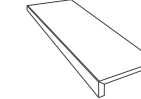

GRADONE TOP

120x32x4,5

1

G0073110

G0073111

G0073112

G0073113

G0073114

G0073115

PZ 202,50

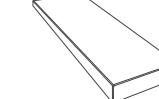

GRADONE ANGOLARE

120x32x4,5

1

G0073120 SX

G0073130 DX

G0073121 SX

G0073131 DX

G0073122 SX

G0073132 DX

G0073123 SX

G0073133 DX

G0073124 SX

G0073134 DX

G0073125 SX

G0073135 DX

PZ 232,90

I dati relativi a imballaggi e pesi possono subire delle variazioni . Informations and details related to packaging and weight are subject to change. Les données concernant emballage et poids sont sujettes à variations . Dieangaben über verpackungen und gewichte sind nicht bindend

CARATTERISTICHE . CHARACTERISTICS . CARACTERISTIQUES . HAUPT EIGENSCHAFTEN

Classificazione secondo le norme EN 14411/G Bia

Classification in the accordance with . classification selon les normes . Einstufung nach den Normen

Gres porcellanato tutta massa . Full body porcelain

SHADE VARIATION VARIAZIONE CROMATICA

V3 moderata variazione / moderate variation
V4* forte variazione / substantial variation

*Colori/Colours: Antracite Corten; Nero Corten

8,5MM: 100X100 (40"X40") NAT | 60X120 (24"X48") NAT | 60X60 (24"X24") NAT | 30X60 (12"X24") NAT | 80X80 (32"X32") NAT, R11 | 40X80 (16"X32") NAT
20MM: 80X80 (32"X32") R11

PROPRIETÀ FISICO-CHIMICHE PHYSICAL-CHEMICAL PROPERTIES	NORMA NORM	VALORE PRESCRITTO DALLE NORME VALUE PRESCRIBED FROM THE NORMS	VALORE GARDENIA* GARDENIA VALUE*
RESISTENZA ALLO SCIVOLAMENTO . SLIP RESISTANCE	B.C.R.A. C.A.	μ 0,19 SCIVOLOSITÀ PERICOLOSA . DANGEROUSLY SLIPPERY $0,20 < \mu < 0,39$ SCIVOLOSITÀ ECCESSIVA . EXCESSIVELY SLIPPERY $0,40 < \mu < 0,74$ ATTRITO SODDISFACENTE . SATISFACTORY GRIP μ 0,75 ATTRITO ECCELLENTE . EXCELLENT GRIP	> 0,40
	B.C.R.A. G.B.		> 0,40
RESISTENZA ALLO SCIVOLAMENTO . SLIP RESISTANCE	ASTM C 1028 (S.C.O.F.)	SLIP RESISTANT (> 0,60)	> 0,60 DRY > 0,60 WET
	DIN EN 16165 B	IN FUNZIONE DELL'AMBIENTE O DELLA ZONA DI LAVORO BASING ON THE ENVIRONMENT OR THE WORKING AREA	R10 (NAT.) - R11 (R11)
	DIN EN 16165 A	-	B (NAT.) - C (R11)
	ANSI A 137-1.2012	$\geq 0,42$	> 0,42

*importante: rispondenti ai valori medi di produzione - nessun riferimento al lotto fornito. - Important: responding to average production values - no reference to the batch supplied

About us

Style
Group
Technology
6mm
Collections

Interiors

MARBLE

La Marmoteca

STONE

La Geoteca

Pietra Viva

Origini

Concept Stone

Burlington Stone

RESIN

I Pigmenti

SOLID COLORS

Chrome

METAL

Oxide

CONCRETE

Make

WOOD

Just Code

Just Nature

Just Color

Decor

Boiserie

Gioia

Technical Info

Technical info

Outdoor

STONE

La Geoteca

Pietra Viva

Origini

Fusion

Burlington Stone

Concept Stone

Antiqua

Soul

Suisse

RESIN

I Pigmenti

METAL

Oxide

CONCRETE

Make

Native

Mesh Up

WOOD

Just Code

Timber

Woodland

INDEX

Just Code

GRES FINE PORCELLANATO A MASSA COLORATA
COLORBODY FINE PORCELAIN STONEWARE



2 SUPERFICI . SURFACES

Natural R10
Outdoor R11



2 FORMATI . SIZES

26,5X180 . 10,5"X72"
30X120 . 12"X48"
20X120 . 8"X48"



2 SPESSORI . THICKNESSES

8,5MM - 20MM



White



Miele



Rovere



Beige



Greige



Complete
collection



Floor
Rovere 20x120

About us

Style
Group
Technology
6mm
Collections

Outdoor

STONE
La Geoteca
Pietra Viva
Origini
Fusion
Burlington Stone
Concept Stone
Antiqua
Soul
Suisse

Interiors

MARBLE
La Marmoteca

STONE
La Geoteca
Pietra Viva
Origini
Concept Stone
Burlington Stone

RESIN
I Pigmenti

SOLID COLORS
Chrome

METAL
Oxide

CONCRETE
Make

WOOD
Just Code
Just Nature
Just Color

RESIN
I Pigmenti

METAL
Oxide

CONCRETE
Make
Native
Mesh Up

WOOD
Just Code
Timber
Woodland

Decor

Boiserie
Gioia

Technical Info

Technical info

INDEX

About us

Style
Group
Technology
6mm
Collections

Interiors

MARBLE

La Marmoteca

STONE

La Geoteca
Pietra Viva
Origini
Concept Stone
Burlington Stone

RESIN

I Pigmenti

SOLID COLORS

Chrome

METAL

Oxide

CONCRETE

Make

WOOD

Just Code
Just Nature
Just Color

Decor

Boiserie
Gioia

Technical Info

Technical info

Outdoor

STONE

La Geoteca
Pietra Viva
Origini
Fusion
Burlington Stone
Concept Stone
Antiqua
Soul
Suisse

RESIN

I Pigmenti

METAL

Oxide

CONCRETE

Make
Native
Mesh Up

WOOD

Just Code
Timber
Woodland

INDEX

Floor indoor
Beige 20x120

Wall
Beige 20x120
I Pigmenti Mud 120x280



MIELE



BEIGE



ROVERE

About us

Style
Group
Technology
6mm
Collections

Interiors

MARBLE
La Marmoteca

STONE
La Geoteca
Pietra Viva
Origini
Concept Stone
Burlington Stone

RESIN
I Pigmenti

SOLID COLORS
Chrome

METAL
Oxide

CONCRETE
Make

WOOD
Just Code
Just Nature
Just Color

Decor

Boiserie
Gioia

Outdoor

STONE
La Geoteca
Pietra Viva
Origini
Fusion
Burlington Stone
Concept Stone
Antiqua
Soul
Suisse

RESIN
I Pigmenti

METAL
Oxide

CONCRETE
Make
Native
Mesh Up

WOOD
Just Code
Timber
Woodland

Technical Info

Technical info

INDEX

26,5x180 **20x120**

MIELE	G0075005	G0075025
BEIGE	G0075001	G0075021
PRICE LIST €	F 74,50	F 47,90

26,5x180 **20x120**

ROVERE	G0075007	G0075027
PRICE LIST €	F 74,50	F 47,90



WHITE

GREIGE

	26,5x180	20x120	30x120
WHITE	G0075006	G0075026	
GREIGE	G0075004	G0075024	G0075114
PRICE LIST €	F 74,50	F 47,90	F 89,50

MOSAICI E PEZZI SPECIALI
SPECIAL TRIMS
PIECES SPECIALES
SONDERSTÜCKE

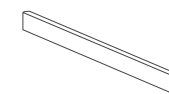

BATTISCOPIA MOLATO
6,5x120
6

MIELE	GML75025
BEIGE	GML75021
GREIGE	GML75024
WHITE	GML75026
ROVERE	GML75027

PRICE LIST € PZ 21,50

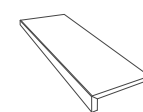

GRADONE TOP
120x32x4
1

G0075065
G0075061
G0075064
G0075066
G0075067

PZ 202,50

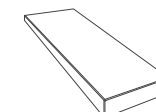

GRADONE ANGOLARE
120x32x4
1

G0075085 SX
G0075075 DX
G0075081 SX
G0075071 DX
G0075084 SX
G0075074 DX
G0075086 SX
G0075076 DX
G0075087 SX
G0075077 DX

PZ 232,90

I dati relativi a imballaggi e pesi possono subire delle variazioni . Informations and details related to packaging and weight are subject to change. Les données concernant emballage et poids sont sujettes à variations . Dieangaben über verpackungen und gewichte sind nicht bindend

CARATTERISTICHE .CHARACTERISTICS . CARACTERISTIQUES . HAUPT-EIGENSCHAFTEN

Classificazione secondo le norme EN 14411/G Bia
Classification in the accordance with . classification selon les normes . Einstufung nach den Normen

Gres porcellanato pressato a secco . Dry-pressed ceramic tiles . Fine porcelaine . Stonewareporcelain

8,5MM: 26,5X180 (10"X72") NAT. | 30X120 (12"X48") NAT. | 20X120 (8"X48") NAT., R1
20MM: 30X120 (12"X48") R11

PROPRIETÀ FISICO-CHIMICHE PHYSICAL-CHEMICAL PROPERTIES	NORMA NORM	VALORE PRESCRITTO DALLE NORME VALUE PRESCRIBED FROM THE NORMS	VALORE GARDENIA* GARDENIA VALUE*
RESISTENZA ALLO SCIVOLAMENTO . SLIP RESISTANCE	B.C.R.A. C.A.	μ 0,19 SCIVOLOSITÀ PERICOLOSA . DANGEROUSLY SLIPPERY 0,20 < μ < 0,39 SCIVOLOSITÀ ECCESSIVA . EXCESSIVELY SLIPPERY 0,40 < μ < 0,74 ATTRITO SODDISFACENTE . SATISFACTORY GRIP μ 0,75 ATTRITO ECCELLENTE . EXCELLENT GRIP	> 0,40
	B.C.R.A. G.B.		> 0,40
RESISTENZA ALLO SCIVOLAMENTO . SLIP RESISTANCE	ASTM C 1028 (S.C.O.F.)	SLIP RESISTANT (> 0,60)	> 0,60 DRY > 0,60 WET
	DIN EN 16165 B	IN FUNZIONE DELL'AMBIENTE O DELLA ZONA DI LAVORO BASING ON THE ENVIRONMENT OR THE WORKING AREA	R10 (NAT.) - R11 (R11)
	DIN EN 16165 A	-	A (NAT.) - A+B+C (R11)
	ANSI A 137-1:2012	\geq 0,42	> 0,42

*importante: rispondenti ai valori medi di produzione - nessun riferimento al lotto fornito. - Important: responding to average production values - no reference to the batch supplied

About us

Style
Group
Technology
6mm
Collections

Interiors

MARBLE
La Marmoteca

STONE
La Geoteca
Pietra Viva
Origini
Concept Stone
Burlington Stone

RESIN
I Pigmenti

SOLID COLORS
Chrome

METAL
Oxide

CONCRETE
Make

WOOD
Just Code
Just Nature
Just Color

Decor

Boiserie
Gioia

Technical Info

Technical info

Outdoor

STONE
La Geoteca
Pietra Viva
Origini
Fusion
Burlington Stone
Concept Stone
Antiqua
Soul
Suisse

RESIN
I Pigmenti

METAL
Oxide

CONCRETE
Make
Native
Mesh Up

WOOD
Just Code
Timber
Woodland

IND
D
EX

Just Nature

GRES FINE PORCELLANATO A MASSA COLORATA
COLORBODY FINE PORCELAIN STONEWARE



2 SUPERFICI . SURFACES

Natural R10
Outdoor R11



2 FORMATI . SIZES

30X120 . 12"X48"
20X120 . 8"X48"



1 SPESSORE . THICKNESS

8,5MM



Beige Chiaro



Beige Medio



Beige Scuro



Noce Scuro



Sbiancato



Grigio



Complete
collection



Floor
Beige Scuro 20x120

About us

Style
Group
Technology
6mm
Collections

Outdoor

STONE
La Geoteca
Pietra Viva
Origini
Fusion
Burlington Stone
Concept Stone
Antiqua
Soul
Suisse

Interiors

MARBLE
La Marmoteca

STONE
La Geoteca
Pietra Viva
Origini
Concept Stone
Burlington Stone

RESIN
I Pigmenti

SOLID COLORS
Chrome

METAL
Oxide

CONCRETE
Make

WOOD
Just Code
Just Nature
Just Color

RESIN
I Pigmenti

METAL
Oxide

CONCRETE
Make
Native
Mesh Up

WOOD
Just Code
Timber
Woodland

Decor

Boiserie
Gioia

Technical Info

Technical info

INDEX



Floor
Noce Scuro 20x120

About us

- Style
- Group
- Technology
- 6mm
- Collections

Interiors

- MARBLE**
 - La Marmoteca
- STONE**
 - La Geoteca
 - Pietra Viva
 - Origini
 - Concept Stone
 - Burlington Stone
- RESIN**
 - I Pigmenti
- SOLID COLORS**
 - Chrome
- METAL**
 - Oxide
- CONCRETE**
 - Make
- WOOD**
 - Just Code
 - Just Nature
 - Just Color

Decor

- Boiserie
- Gioia

Technical Info

Technical info

Outdoor

- STONE**
 - La Geoteca
 - Pietra Viva
 - Origini
 - Fusion
 - Burlington Stone
 - Concept Stone
 - Antiqua
 - Soul
 - Suisse
- RESIN**
 - I Pigmenti
- METAL**
 - Oxide
- CONCRETE**
 - Make
- WOOD**
 - Just Code
 - Timber
 - Woodland

INDEX



BEIGE CHIARO



BEIGE MEDIO



BEIGE SCURO



NOCE SCURO

About us

- Style
- Group
- Technology
- 6mm
- Collections

Interiors

- MARBLE**
 - La Marmoteca
- STONE**
 - La Geoteca
 - Pietra Viva
 - Origini
 - Concept Stone
 - Burlington Stone
- RESIN**
 - I Pigmenti
- SOLID COLORS**
 - Chrome
- METAL**
 - Oxide
- CONCRETE**
 - Make
- WOOD**
 - Just Code
 - Just Nature
 - Just Color

Outdoor

- STONE**
 - La Geoteca
 - Pietra Viva
 - Origini
 - Fusion
 - Burlington Stone
 - Concept Stone
 - Antiqua
 - Soul
 - Suisse
- RESIN**
 - I Pigmenti
- METAL**
 - Oxide
- CONCRETE**
 - Make
 - Native
 - Mesh Up
- WOOD**
 - Just Code
 - Timber
 - Woodland

Decor

- Boiserie
- Gioia

Technical Info

Technical info

INDEX

30x120 **20x120**

BEIGE CHIARO	G0052002	G0052012
BEIGE MEDIO	G0052006	G0052016
PRICE LIST €	F 53,50	F 47,90

30x120 **20x120**

BEIGE SCURO	G0052003	G0052013
NOCE SCURO	G0052005	G0052015
PRICE LIST €	F 53,50	F 47,90



SBIANCATO



GRIGIO

	30x120	20x120
SBIANCATO	G0052000	G0052010
GRIGIO	G0052001	G0052011
PRICE LIST €	F 53,50	F 47,90

MOSAICI E PEZZI SPECIALI
SPECIAL TRIMS
PIECES SPECIALES
SONDERSTÜCKE

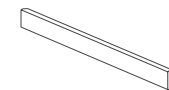

BATTISCOPA MOLATO
7x120
4

BEIGE CHIARO	GML52002
BEIGE MEDIO	GML52006
BEIGE SCURO	GML52003
NOCE SCURO	GML52005
SBIANCATO	GML52000
GRIGIO	GML52001

PRICE LIST € PZ 21,50

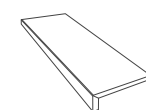

GRADONE TOP
120x32x4
1

G0052102
G0052106
G0052103
G0052105
G0052100
G0052101

PZ 202,50

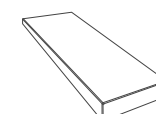

GRADONE ANGOLARE
120x32x4
1

G0052112 DX
G0052122 SX
G0052116 DX
G0052126 SX
G0052113 DX
G0052123 SX
G0052115 DX
G0052125 SX
G0052110 DX
G0052120 SX
G0052111 DX
G0052121 SX

PZ 232,90

I dati relativi a imballaggi e pesi possono subire delle variazioni. Informations and details related to packaging and weight are subject to change. Les données concernant emballage et poids sont sujettes à variations. Die Angaben über verpackungen und gewichte sind nicht bindend

CARATTERISTICHE .CHARACTERISTICS . CARACTERISTIQUES . HAUPTEIGENSCHAFTEN

Classificazione secondo le norme EN 14411/G Bia

Classification in the accordance with . classification selon les normes . Einstufung nach den Normen

Gres porcellanato pressato a secco . Dry-pressed ceramic tiles . Fine porcelaine . Stonewareporcelain

8,5MM: 20X120 (8"X48") NAT., 30X120 (12"X48") NAT.

SHADE VARIATION
VARIAZIONE CROMATICA

V3
moderata variazione
moderate variation

PROPRIETÀ FISICO-CHIMICHE PHYSICAL-CHEMICAL PROPERTIES	NORMA NORM	VALORE PRESCRITTO DALLE NORME VALUE PRESCRIBED FROM THE NORMS	VALORE GARDENIA* GARDENIA VALUE*
	B.C.R.A. C.A.	μ 0,19 SCIVOLOSITÀ PERICOLOSA . DANGEROUSLY SLIPPERY 0,20 < μ < 0,39 SCIVOLOSITÀ ECCESSIVA . EXCESSIVELY SLIPPERY	> 0,40
	B.C.R.A. G.B.	0,40 < μ < 0,74 ATTRITO SODDISFACENTE . SATISFACTORY GRIP μ 0,75 ATTRITO ECCELLENTE . EXCELLENT GRIP	> 0,40
RESISTENZA ALLO SCIVOLAMENTO . SLIP RESISTANCE	ASTM C 1028 (S.C.O.F.)	SLIP RESISTANT (> 0,60)	> 0,60 DRY > 0,60 WET
	DIN EN 16165 B	IN FUNZIONE DELL'AMBIENTE O DELLA ZONA DI LAVORO BASING ON THE ENVIRONMENT OR THE WORKING AREA	R10 (NAT.) - R11 (R11)
	DIN EN 16165 A	-	A+B (NAT.) - A+B+C (R11)
	ANSI A 137-1:2012	\geq 0,42	> 0,42

*importante: rispondenti ai valori medi di produzione - nessun riferimento al lotto fornito. - Important: responding to average production values - no reference to the batch supplied

About us

Style
Group
Technology
6mm
Collections

Interiors

MARBLE
La Marmoteca

STONE
La Geoteca
Pietra Viva
Origini
Concept Stone
Burlington Stone

RESIN
I Pigmenti

SOLID COLORS
Chrome

METAL
Oxide

CONCRETE
Make

WOOD
Just Code
Just Nature
Just Color

Decor

Boiserie
Gioia

Technical Info

Technical info

Outdoor

STONE
La Geoteca
Pietra Viva
Origini
Fusion
Burlington Stone
Concept Stone
Antiqua
Soul
Suisse

RESIN
I Pigmenti

METAL
Oxide

CONCRETE
Make
Native
Mesh Up

WOOD
Just Code
Timber
Woodland

INDEX

Just Color

GRES FINE PORCELLANATO A MASSA COLORATA
COLORBODY FINE PORCELAIN STONEWARE



SUPERFICIE . SURFACE

Natural R10



1 FORMATO . SIZE

20X120 . 8"X48"



SPESSORE . THICKNESS

8,5MM



White



Blue



Almond



Honey



Complete
collection



Floor
Almond 20x120

About us

- Style
- Group
- Technology
- 6mm
- Collections

Outdoor

- STONE**
- La Geoteca
- Pietra Viva
- Origini
- Fusion
- Burlington Stone
- Concept Stone
- Antiqua
- Soul
- Suisse

Interiors

- MARBLE**
- La Marmoteca

- STONE**
- La Geoteca
- Pietra Viva
- Origini
- Concept Stone
- Burlington Stone

- RESIN**
- I Pigmenti

- SOLID COLORS**
- Chrome

- METAL**
- Oxide

- CONCRETE**
- Make

- WOOD**
- Just Code
- Just Nature
- Just Color

- RESIN**
- I Pigmenti

- METAL**
- Oxide

- CONCRETE**
- Make
- Native
- Mesh Up

- WOOD**
- Just Code
- Timber
- Woodland

Decor

- Boiserie
- Gioia

Technical Info

Technical info

INDEX



WHITE

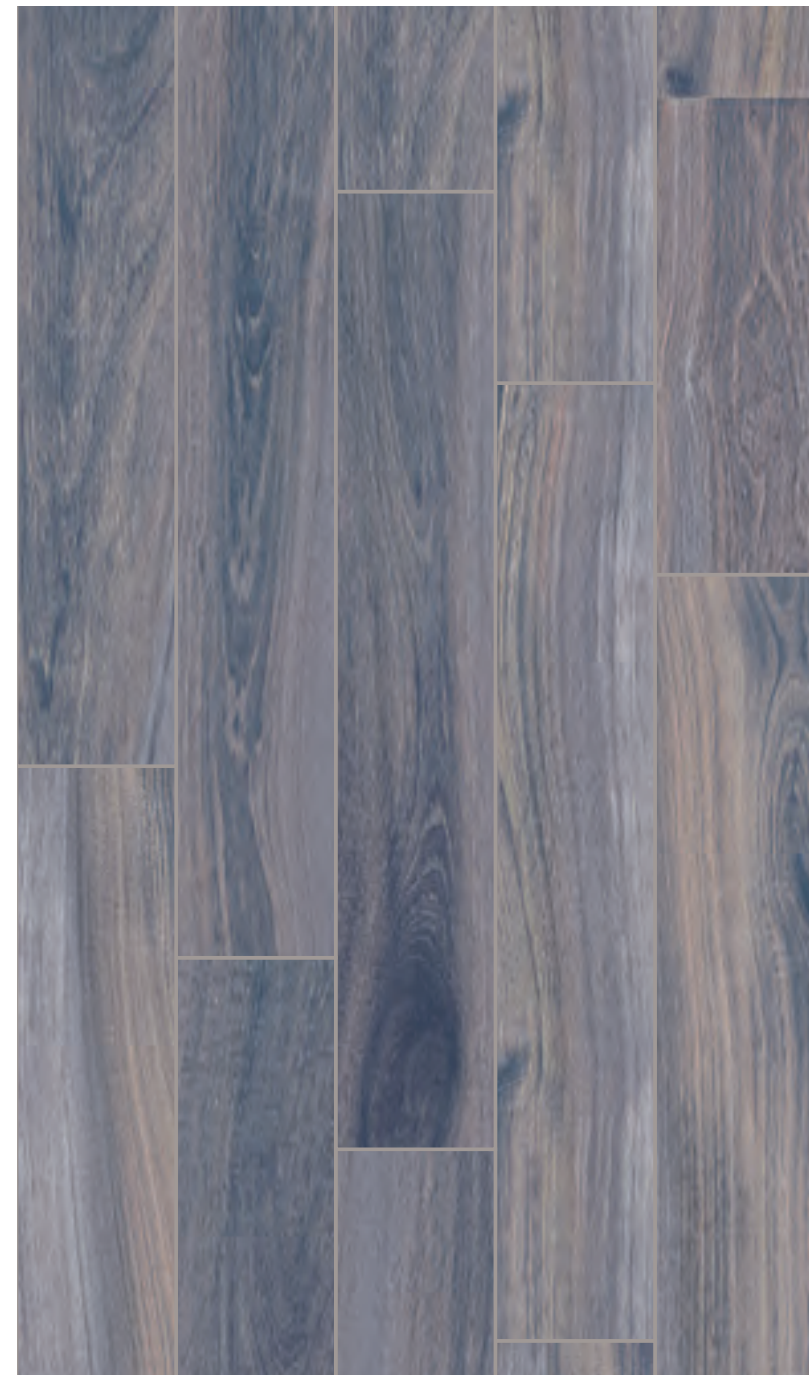

BLUE



ALMOND



HONEY

About us

Style
Group
Technology
6mm
Collections

Interiors

MARBLE
La Marmoteca

STONE
La Geoteca
Pietra Viva
Origini
Concept Stone
Burlington Stone

RESIN
I Pigmenti

SOLID COLORS
Chrome

METAL
Oxide

CONCRETE
Make

WOOD
Just Code
Just Nature
Just Color

Decor

Boiserie
Gioia

Outdoor

STONE
La Geoteca
Pietra Viva
Origini
Fusion
Burlington Stone
Concept Stone
Antiqua
Soul
Suisse

RESIN
I Pigmenti

METAL
Oxide

CONCRETE
Make
Native
Mesh Up

WOOD
Just Code
Timber
Woodland

Technical Info

Technical info

INDEX

20x120

WHITE	G0058600
PRICE LIST €	F 47,90

20x120

BLUE	G0058604
PRICE LIST €	F 47,90

20x120

ALMOND	G0058601
HONEY	G0058602
PRICE LIST €	F 47,90



Floor
Almond 20x120

Just Color

INTERIORS WOOD

MOSAICI E PEZZI SPECIALI
SPECIAL TRIMS
PIECES SPECIALES
SONDERSTÜCKE

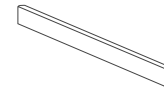

BATTISCOPIA MOLATO
6x120
6

WHITE

GML58600

ALMOND

GML58601

HONEY

GML58602

BLUE

GML58604

PRICE LIST €

PZ 21,50

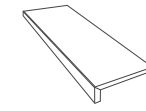

GRADONE TOP

120x32x4
1

G0058640

G0058641

G0058642

G0058644

PZ 202,50

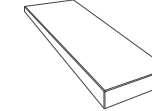

GRADONE ANGOLARE

120x32x4
1

G0058650 DX

G0058660 SX

G0058651 dx

G0058661 sx

G0058652 DX

G0058662 SX

G0058654 DX

G0058664 SX

PZ 232,90

I dati relativi a imballaggi e pesi possono subire delle variazioni . Informations and details related to packaging and weight are subject to change. Les données concernant emballage et poids sont sujettes à variations . Dieangaben über verpackungen und gewichte sind nicht bindend

CARATTERISTICHE .CHARACTERISTICS . CARACTERISTIQUES . HAUPTZEIGENSCHAFTEN

Classificazione secondo le norme EN 14411/G Bia

Classification in the accordance with . classification selon les normes . Einstufung nach den Normen

Gres porcellanato pressato a secco . Dry-pressed ceramic tiles . Fine porcelaine . Stonewareporcelain

8,5MM: 20X120 (8"X48") NAT.

SHADE VARIATION VARIAZIONE CROMATICA

V4
forte variazione
substantial variation

PROPRIETÀ FISICO-CHIMICHE PHYSICAL-CHEMICAL PROPERTIES	NORMA NORM	VALORE PRESCRITTO DALLE NORME VALUE PRESCRIBED FROM THE NORMS	VALORE GARDENIA* GARDENIA VALUE*
	B.C.R.A. C.A.	μ 0,19 SCIVOLOSITÀ PERICOLOSA . DANGEROUSLY SLIPPERY 0,20 < μ < 0,39 SCIVOLOSITÀ ECCESSIVA . EXCESSIVELY SLIPPERY	> 0,40
	B.C.R.A. G.B.	0,40 < μ < 0,74 ATTRITO SODDISFACENTE . SATISFACTORY GRIP μ 0,75 ATTRITO ECCELLENTE . EXCELLENT GRIP	> 0,40
RESISTENZA ALLO SCIVOLAMENTO . SLIP RESISTANCE	ASTM C 1028 (S.C.O.F)	SLIP RESISTANT (> 0,60)	> 0,60 DRY > 0,60 WET
	DIN EN 16165 B	IN FUNZIONE DELL'AMBIENTE O DELLA ZONA DI LAVORO BASING ON THE ENVIRONMENT OR THE WORKING AREA	R10
	DIN EN 16165 A	-	A
	ANSI A 137-1:2012	\geq 0,42	> 0,42

*importante: rispondenti ai valori medi di produzione - nessun riferimento al lotto fornito. - Important: responding to average production values - no reference to the batch supplied

About us

Style
Group
Technology
6mm
Collections

Interiors

MARBLE
La Marmoteca

STONE
La Geoteca
Pietra Viva
Origini
Concept Stone
Burlington Stone

RESIN
I Pigmenti

SOLID COLORS
Chrome

METAL
Oxide

CONCRETE
Make

WOOD
Just Code
Just Nature
Just Color

Decor

Boiserie
Gioia

Technical Info

Technical info

Outdoor

STONE
La Geoteca
Pietra Viva
Origini
Fusion
Burlington Stone
Concept Stone
Antiqua
Soul
Suisse

RESIN
I Pigmenti

METAL
Oxide

CONCRETE
Make
Native
Mesh Up

WOOD
Just Code
Timber
Woodland

INDEX

DECOR

168 Boiserie
174 Gioia



About us

Style
Group
Technology
6mm
Collections

Interiors

MARBLE
La Marmoteca

STONE
La Geoteca
Pietra Viva
Origini
Concept Stone
Burlington Stone

RESIN
I Pigmenti

SOLID COLORS
Chrome

METAL
Oxide

CONCRETE
Make

WOOD
Just Code
Just Nature
Just Color

Decor

Boiserie
Gioia

Technical Info

Technical info

Outdoor

STONE
La Geoteca
Pietra Viva
Origini
Fusion
Burlington Stone
Concept Stone
Antiqua
Soul
Suisse

RESIN
I Pigmenti

METAL
Oxide

CONCRETE
Make
Native
Mesh Up

WOOD
Just Code
Timber
Woodland

INDEX

DECOR

Boiserie

GRES FINE PORCELLANATO A MASSA COLORATA
COLORBODY FINE PORCELAIN STONEWARE



SUPERFICIE . SURFACE

Natural



1 FORMATO . SIZE

60X120 . 24"X48"



SPESSORE . THICKNESS

8,5MM



White



Beige



Green



Dark



Complete collection



Floor
I Pigmenti Cotto 20x120

Wall
Boiserie Beige 60x120
Boiserie Terminale Beige 20x60
Boiserie Battiscopa Beige 10x60

About us

Style
Group
Technology
6mm
Collections

Interiors

MARBLE
La Marmoteca

STONE
La Geoteca
Pietra Viva
Origini
Concept Stone
Burlington Stone

RESIN
I Pigmenti

SOLID COLORS
Chrome

METAL
Oxide

CONCRETE
Make

WOOD
Just Code
Just Nature
Just Color

Decor

Boiserie
Gioia

Technical Info

Technical info

Outdoor

STONE
La Geoteca
Pietra Viva
Origini
Fusion

Burlington Stone
Concept Stone

Antiqua
Soul
Suisse

RESIN
I Pigmenti

METAL
Oxide

CONCRETE
Make
Native
Mesh Up

WOOD
Just Code
Timber
Woodland

INDEX



Floor
La Geoteca Cardoso 120x120

Wall
Square White 60x120
La Geoteca Serena 60x120

Boiserie

DECOR



Floor
Just Code Beige 20x120

Wall
Green 60x120
Gioia Latte 60x120
Gioia Primavera 60x120

About us

Style
Group
Technology
6mm
Collections

Interiors

MARBLE
La Marmoteca

STONE
La Geoteca
Pietra Viva
Origini
Concept Stone
Burlington Stone

RESIN
I Pigmenti

SOLID COLORS
Chrome

METAL
Oxide

CONCRETE
Make

WOOD
Just Code
Just Nature
Just Color

Decor

Boiserie
Gioia

Technical
Info

Technical info

Outdoor

STONE

La Geoteca
Pietra Viva
Origini
Fusion

Burlington Stone
Concept Stone

Antiqua
Soul
Suisse

RESIN
I Pigmenti

METAL
Oxide

CONCRETE
Make

Native
Mesh Up

WOOD
Just Code

Timber
Woodland

INDEX

DECORO BOISERIE 60x120 F 90,90

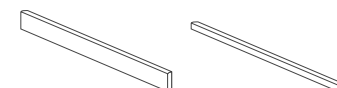
60x120
WHITE
001792360x120
DARK
001792460x120
BEIGE
001792560x120
GREEN
001792660x120
SQUARE WHITE
001792760x120
SQUARE DARK
0017928
MOSAICI E PEZZI SPECIALI
 SPECIAL TRIMS
 PIÈCES SPECIALES
 SONDERSTÜCKE

	BATTISCOPA	TERMINALE
	10x60 NAT RET 📦1	2x60 NAT RET 📦1
WHITE	0017934	0017930
GREEN	0017935	0017931
DARK	0017936	0017932
BEIGE	0017937	0017933
PRICE LIST €	PZ 22,90	PZ 19,50

I dati relativi a imballaggi e pesi possono subire delle variazioni . Informations and details related to packaging and weight are subject to change. Les données concernant emballage et poids sont sujettes à variations . Dieangaben über verpackungen und gewichte sind nicht bindend

CARATTERISTICHE . CHARACTERISTICS . CARACTERISTIQUES . HAUPTEIGENSCHAFTEN

Classificazione secondo le norme EN 14411/G Bla

Classification in the accordance with . classification selon les normes . Einstufung nach den Normen

Gres porcellanato pressato a secco . Dry-pressed ceramic tiles . Fine porcelaine . Stonewareporcelain

8,5MM: 60X120 (24"X48") NAT

PROPRIETÀ FISICO-CHIMICHE PHYSICAL-CHEMICAL PROPERTIES	NORMA NORM	VALORE PRESCRITTO DALLE NORME VALUE PRESCRIBED FROM THE NORMS	VALORE GARDENIA* GARDENIA VALUE*
LUNGHEZZA E LARGHEZZA DIMENSIONE MEDIA DI OGNI PIASTRELLA LENGTH AND WIDTH OF THE AVERAGE-SIZES TILE	UNI EN ISO 10545/2	± 0,5%	CONFORME ACCORDING
SPESSORE . THICKNESS	UNI EN ISO 10545/2	± 0,5%	CONFORME ACCORDING
RETTILINEARITÀ SPIGOLI . WARPAGES OF EDGES	UNI EN ISO 10545/2	± 0,5%	CONFORME ACCORDING
ORTOGONALITÀ . WEDGING	UNI EN ISO 10545/2	± 0,6%	CONFORME ACCORDING
PLANARITÀ . FLATNESS	UNI EN ISO 10545/2	± 0,5%	CONFORME ACCORDING
ASSORBIMENTO D'ACQUA . WATER ABSORPTION	UNI EN ISO 10545/3	E ≤ 0,5%	CONFORME ACCORDING
RESISTENZA ALLA FLESSIONE . BENDING STRENGTH	UNI EN ISO 10545/4	≥ 35 N/MM ²	CONFORME ACCORDING
FORZA DI ROTTURA . BREAKING STRENGTH	UNI EN ISO 10545/4	< 7,5 MM: ≥ 700 N	CONFORME ACCORDING
RESISTENZA ALL'ABRASIONE SUPERFICIALE PER PIASTRELLE GL RESISTANCE TO SURFACE ABRASION OF GLAZED TILES	UNI EN ISO 10545/7	TEST METHOD AVAILABLE	CONFORME ACCORDING
RESISTENZA AGLI SBALZI TERMICI . THERMAL SHOCK RESISTANCE	UNI EN ISO 10545/9	RICHIESTA REQUIRED	RESISTE RESISTS
RESISTENZA AL GELO . FROST RESISTANCE	UNI EN ISO 10545/12	RICHIESTA REQUIRED	INGELIVO FROST PROOF
RESISTENZA ALL'ATTACCO CHIMICO . CHEMICAL RESISTANCE	UNI EN ISO 10545/13	MIN GB	CONFORME ACCORDING
RESISTENZA ALLE MACCHIE . RESISTANCE TO STAINING	UNI EN ISO 10545/14	TEST METHOD AVAILABLE	CONFORME ACCORDING

SHADE VARIATION
VARIAZIONE CROMATICA
 V1
 aspetto uniforme
 uniform appearance

About us

Style
 Group
 Technology
 6mm
 Collections

Interiors

MARBLE
 La Marmoteca

STONE
 La Geoteca
 Pietra Viva
 Origini
 Concept Stone
 Burlington Stone

RESIN
 I Pigmenti

SOLID COLORS
 Chrome

METAL
 Oxide

CONCRETE
 Make

WOOD
 Just Code
 Just Nature
 Just Color

Decor

Boiserie
 Gioia

Technical Info

Technical info

Outdoor

STONE
 La Geoteca
 Pietra Viva
 Origini
 Fusion
 Burlington Stone
 Concept Stone
 Antiqua
 Soul
 Suisse

RESIN
 I Pigmenti

METAL
 Oxide

CONCRETE
 Make
 Native
 Mesh Up

WOOD
 Just Code
 Timber
 Woodland

IND
 D
 EX

Gioia

GRES FINE PORCELLANATO A MASSA COLORATA
COLORBODY FINE PORCELAIN STONEWARE

PASTA BIANCA DA RIVESTIMENTO
WHITE BODY WALL TILES



SUPERFICIE . SURFACE

Natural



1 FORMATO . SIZE

60X120 . 24"X48"



SPESSORE . THICKNESS

7MM



10 TINTA UNITA . SOLID COLORS

8 PATTERN



Latte



Beige



Bouquet



Primavera



Cipria



Corteccia



Martinica



Brit



Cielo



Oceano

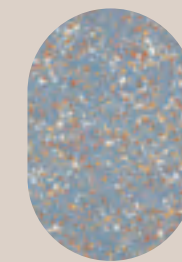

Gocce



Scandi



Salvia



Bosco



Quadra



Cenere



Grafite



Pompei



Complete collection



Best box gallery

About us

Style
Group
Technology
6mm
Collections

Outdoor

STONE
La Geoteca
Pietra Viva
Origini
Fusion
Burlington Stone
Concept Stone

Interiors

MARBLE
La Marmoteca

STONE
La Geoteca
Pietra Viva
Origini
Concept Stone
Burlington Stone

RESIN
I Pigmenti

SOLID COLORS
Chrome

METAL
Oxide

CONCRETE
Make

WOOD
Just Code
Just Nature
Just Color

RESIN
I Pigmenti

METAL
Oxide

CONCRETE
Make
Native
Mesh Up

WOOD
Just Code
Timber
Woodland

Decor

Boiserie
Gioia

Technical Info

Technical info

INDEX



Floor
Oxide Steel 120x120

Wall
Britt 60x120 . Cipria 60x120

Gioia



Floor
Oxide Steel 120x120

Wall
Cielo 60x120 . Gocce 60x120

About us

Style
Group
Technology
6mm
Collections

Interiors

MARBLE
La Marmoteca

STONE
La Geoteca
Pietra Viva
Origini
Concept Stone
Burlington Stone

RESIN
I Pigmenti

SOLID COLORS
Chrome

METAL
Oxide

CONCRETE
Make

WOOD
Just Code
Just Nature
Just Color

Decor

Boiserie
Gioia

Technical Info

Technical info

Outdoor

STONE
La Geoteca
Pietra Viva
Origini
Fusion

Burlington Stone
Concept Stone

Antiqua
Soul
Suisse

RESIN
I Pigmenti

METAL
Oxide

CONCRETE
Make
Native
Mesh Up

WOOD
Just Code
Timber
Woodland

INDEX

Gioia

DECOR



CIPRIA

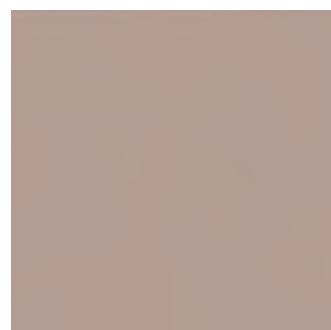

CORTECCIA



CIELO



OCEANO

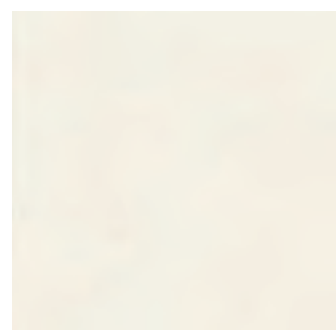

LATTE



BEIGE



SALVIA



BOSCO



GRAFITE



CENERE

60x120

CIPRIA	0008235
CIELO	0008233
LATTE	0008228
CORTECCIA	0009647
OCEANO	0008234
BEIGE	0008230
SALVIA	0008232
GRAFITE	0009649
CENERE	0009646
BOSCO	0009648

PRICE LIST € F 85,90



Floor
La Geoteca Ceppo di Gre 60x120

Wall
Latte 60x120 . Bosco 60x120 . Beige 60x120

About us

Style
Group
Technology
6mm
Collections

Interiors

MARBLE
La Marmoteca

STONE
La Geoteca
Pietra Viva
Origini
Concept Stone
Burlington Stone

RESIN
I Pigmenti

SOLID COLORS
Chrome

METAL
Oxide

CONCRETE
Make

WOOD
Just Code
Just Nature
Just Color

Decor

Boiserie
Gioia

Technical Info

Technical info

Outdoor

STONE

La Geoteca
Pietra Viva
Origini
Fusion

Burlington Stone
Concept Stone

Antiqua
Soul
Suisse

RESIN
I Pigmenti

METAL
Oxide

CONCRETE
Make

Native
Mesh Up

WOOD
Just Code

Timber
Woodland

INDEX



BOUQUET



PRIMAVERA



MARTINICA



BRIT

60x120

BOUQUET	0010526
PRIMAVERA	0010527
PRICE LIST €	F 110,50

60x120

MARTINICA	0009655
BRIT	0009656
PRICE LIST €	F 110,50

Articoli a soggetto unico per posa in continuità grafica.
La ripresa tra le diverse piastrelle è contenuta entro una tolleranza massima di 3mm
Articles with a single graphic pattern for continuous laying.
Items with a graphic clearance among the different slabs ranging within 3mm

About us

Style
Group
Technology
6mm
Collections

Interiors

MARBLE
La Marmoteca
STONE
La Geoteca
Pietra Viva
Origini
Concept Stone
Burlington Stone

RESIN
I Pigmenti

SOLID COLORS
Chrome

METAL
Oxide

CONCRETE
Make

WOOD
Just Code
Just Nature
Just Color

Decor

Boiserie
Gioia

Technical Info

Technical info

Outdoor

STONE
La Geoteca
Pietra Viva
Origini
Fusion
Burlington Stone
Concept Stone
Antiqua
Soul
Suisse

RESIN
I Pigmenti

METAL
Oxide

CONCRETE
Make
Native
Mesh Up

WOOD
Just Code
Timber
Woodland

INDEX

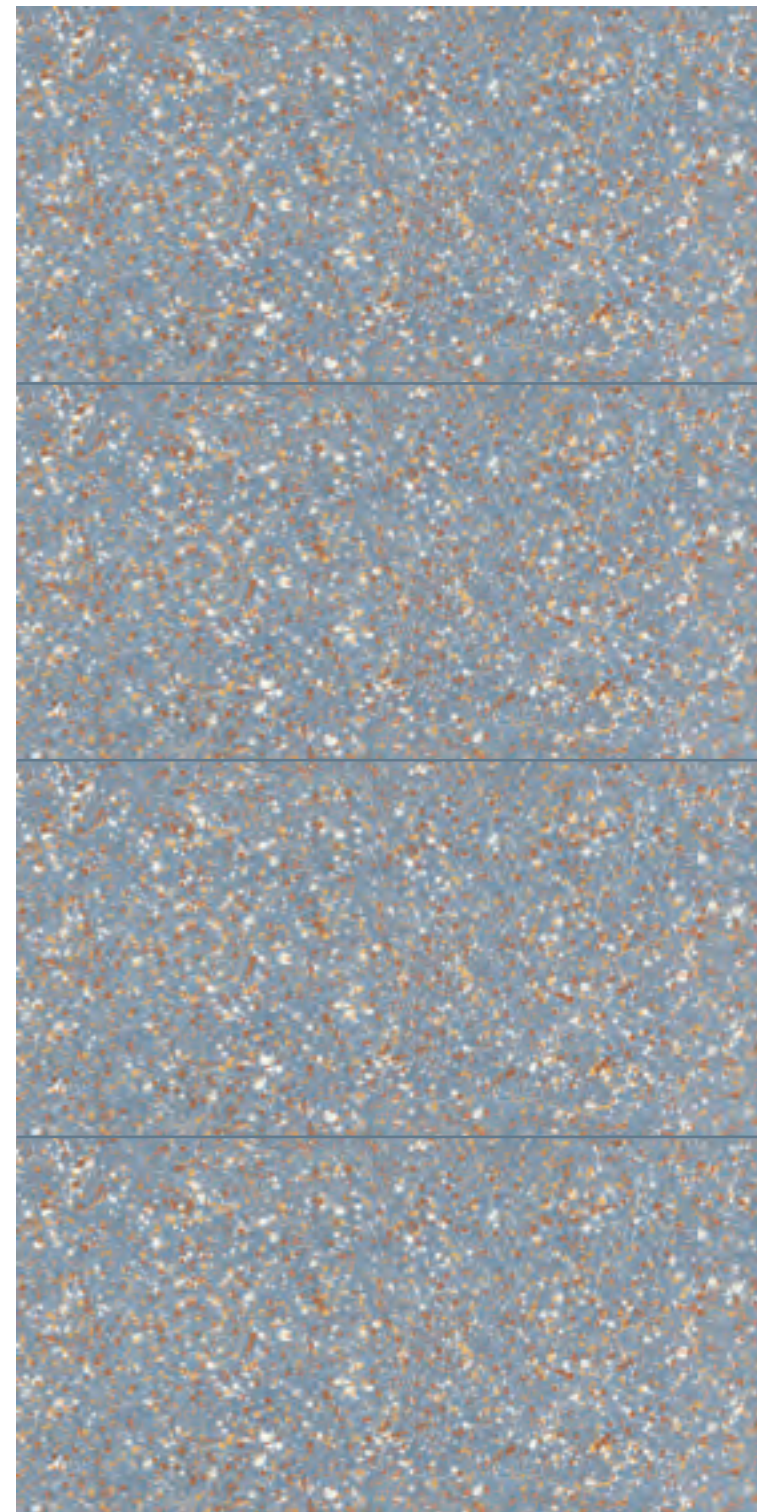

GOCCE



SCANDI

Articoli con sviluppo grafico a 4 soggetti per posa random.
Articles with 4 graphic patterns for random laying.

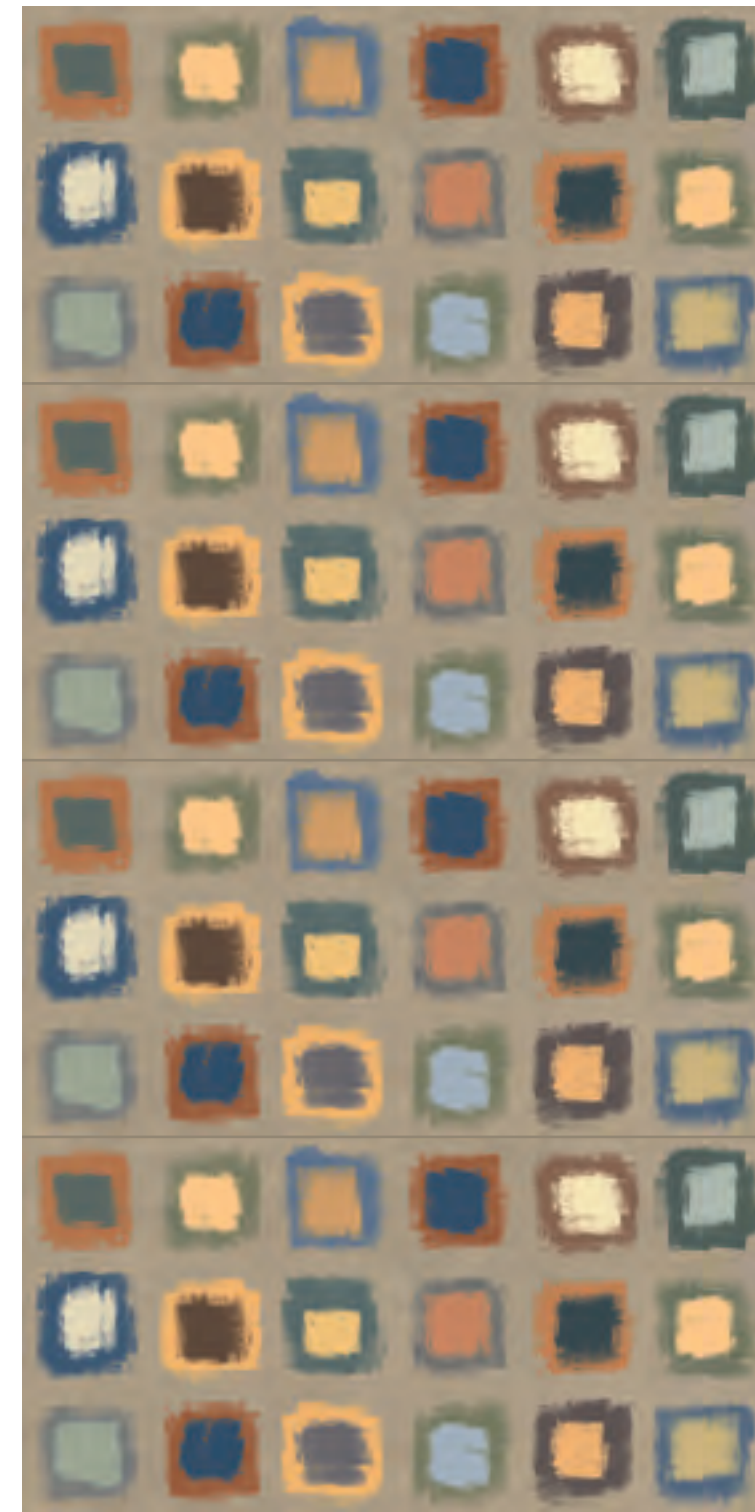

QUADRA

Articoli con sviluppo grafico a 4 soggetti per posa random.
Articles with 4 graphic patterns for random laying.

60x120

GOCCE	0009654
SCANDI	0009653
PRICE LIST €	F 110,50

60x120

QUADRA	0009652
PRICE LIST €	F 110,50

About us

- Style
- Group
- Technology
- 6mm
- Collections

Interiors

MARBLE

- La Marmoteca

STONE

- La Geoteca
- Pietra Viva
- Origini
- Concept Stone
- Burlington Stone

RESIN

- I Pigmenti

SOLID COLORS

- Chrome

METAL

- Oxide

CONCRETE

- Make

WOOD

- Just Code
- Just Nature
- Just Color

Decor

- Boiserie
- Gioia

Technical Info

Technical info

Outdoor

STONE

- La Geoteca
- Pietra Viva
- Origini
- Fusion

- Burlington Stone

- Concept Stone

- Antiqua

- Soul

- Suisse

RESIN

- I Pigmenti

METAL

- Oxide

CONCRETE

- Make

- Native

- Mesh Up

WOOD

- Just Code

- Timber

- Woodland

INDEX



POMPEI

Articoli con sviluppo grafico a 6 soggetti per posa random.
Articles with 6 graphic patterns for random laying.



Wall
Corteccia 60x120 . Pompei 60x120

CARATTERISTICHE .CHARACTERISTICS . CARACTERISTIQUES . HAUPTEIGENSCHAFTEN

Classificazione secondo le norme EN 14411/L-Gruppo BIII
Classification in the accordance with . classification selon les normes . Einstufung nach den Normen

Pasta bianca da rivestimento . White body wall tiles

7MM: 60X120 (24"X48")

*importante: rispondenti ai valori medi di produzione - nessun riferimento al lotto fornito. - Important: responding to average production values - no reference to the batch supplied

About us

Style
Group
Technology
6mm
Collections

Interiors

MARBLE
La Marmoteca
STONE
La Geoteca
Pietra Viva
Origini
Concept Stone
Burlington Stone

RESIN
I Pigmenti

SOLID COLORS
Chrome

METAL
Oxide

CONCRETE
Make

WOOD
Just Code
Just Nature
Just Color

Decor

Boiserie
Gioia

Outdoor

STONE
La Geoteca
Pietra Viva
Origini
Fusion
Burlington Stone
Concept Stone
Antiqua
Soul
Suisse

RESIN
I Pigmenti

METAL
Oxide

CONCRETE
Make
Native
Mesh Up

WOOD
Just Code
Timber
Woodland

Technical Info

Technical info

INDEX

60x120	
POMPEI	0009650
PRICE LIST €	F 110,50

OUTDOOR

STONE

- 190 La Geoteca
- 191 Pietra Viva
- 193 Origini
- 193 Fusion
- 194 Burlington Stone
- 194 Concept Stone
- 195 Antiqua
- 195 Soul
- 195 Suisse

RESIN

- 196 I Pigmenti

METAL

- 199 Oxide

CONCRETE

- 199 Make
- 200 Native
- 200 Mesh up

WOOD

- 203 Just Code
- 205 Timber
- 205 Woodland



About us

- Style
- Group
- Technology
- 6mm
- Collections

Interiors

MARBLE

- La Marmoteca

STONE

- La Geoteca
- Pietra Viva
- Origini
- Concept Stone
- Burlington Stone

RESIN

- I Pigmenti

SOLID COLORS

- Chrome

METAL

- Oxide

CONCRETE

- Make

WOOD

- Just Code
- Just Nature
- Just Color

Decor

- Boiserie
- Gioia

Technical Info

- Technical info

Outdoor

STONE

- La Geoteca
- Pietra Viva
- Origini
- Fusion

- Burlington Stone

- Concept Stone

- Antiqua

- Soul

- Suisse

RESIN

- I Pigmenti

METAL

- Oxide

CONCRETE

- Make

- Native

- Mesh Up

WOOD

- Just Code

- Timber

- Woodland

INDEX

Un sistema concepito Per ogni spazio esterno

- 1 Aree e viali carrabili
Driveways and parking areas
- 2 Passi giapponesi
e camminamenti su prato
Japanese stepping stones
and lawn walkways
- 3 Cortili e living esterni
Courtyards and outdoor
living areas
- 4 Terrazze con posa sopraelevata
Terraces with a raised laying
system
- 5 Arredo urbano e fioriere
Street furniture and planters
- 6 Zone Piscina
Pool areas
- 7 Scalini
Steps



Superfici antiscivolo pensate anche per i luoghi del benessere

- Piscine Outdoor
Outdoor pools 1
- Docce Esterne
External showers 2
- Camminamento
piscina indoor
Indoor pool walkway 3
- Camminamento
piscina outdoor
Outdoor pool walkway 4



A SYSTEM DESIGNED
FOR ANY EXTERNAL SPACE

ANTISLIP SURFACES ALSO DESIGNED
FOR WELLNESS LOCATIONS

About us

Style
Group
Technology
6mm
Collections

Interiors

MARBLE
La Marmoteca

STONE
La Geoteca
Pietra Viva
Origini
Concept Stone
Burlington Stone

RESIN
I Pigmenti

SOLID COLORS
Chrome

METAL
Oxide

CONCRETE
Make

WOOD
Just Code
Just Nature
Just Color

Decor

Boiserie
Gioia

Technical Info

Technical info

Outdoor

STONE
La Geoteca
Pietra Viva
Origini
Fusion
Burlington Stone
Concept Stone
Antiqua
Soul
Suisse

RESIN
I Pigmenti

METAL
Oxide

CONCRETE
Make
Native
Mesh Up

WOOD
Just Code
Timber
Woodland

INDEX

La Geoteca [®] R11

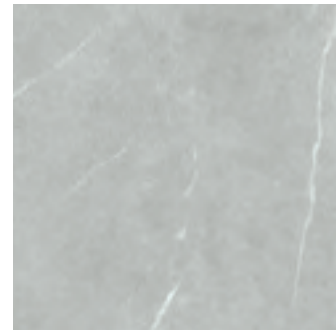

SERENA
20MM
80x80 32"x32" 0012083 F 84,50
60x120 24"x48" 0014520 F 89,50

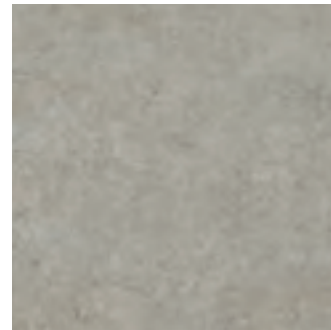

VICENZA
20MM
80x80 32"x32" 0012084 F 84,50
60x120 24"x48" 0014521 F 89,50
8,5MM
80x80 32"x32" 0013053 F 56,90

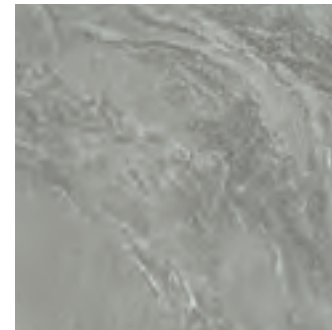

BRENNERO
20MM
80x80 32"x32" 0012085 F 84,50
60x120 24"x48" 0014522 F 89,50
8,5MM
80x80 32"x32" 0013054 F 56,90

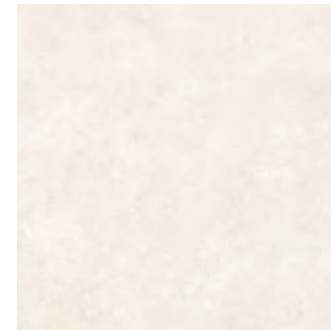

LIMESTONE
20MM
80x80 32"x32" 0012086 F 84,50
60x120 24"x48" 0014523 F 89,50
8,5MM
80x80 32"x32" 0013055 F 56,90

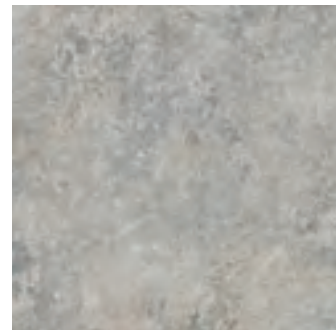

PROVENCE
20MM
80x80 32"x32" 0012087 F 84,50
60x120 24"x48" 0014524 F 89,50
8,5MM
80x80 32"x32" 0013056 F 56,90



CEPPO DI GRE
20MM
80x80 32"x32" 0013072 F 84,50
60x120 24"x48" 0014525 F 89,50



BOURGOGNE BEIGE
20MM
80x80 32"x32" 0016026 F 84,50



BOURGOGNE SILVER
20MM
80x80 32"x32" 0016027 F 84,50



TRAVERTINO IVORY CROSS
20MM
80x80 32"x32" 0016183 F 84,50



TRAVERTINO IVORY VEIN
20MM
80x80 32"x32" 0016184 F 84,50

Pietra Viva [®] R11

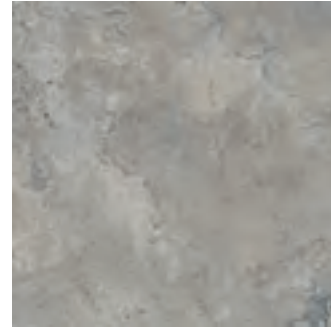

GREY
20MM
80x80 32"x32" 0012266 F 82,90
60x60 24"x24" 0014518 F 75,90

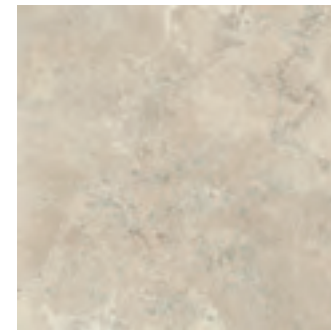

BEIGE
20MM
80x80 32"x32" 0012267 F 82,90
60x60 24"x24" 0014519 F 75,90



Floor
Pietra Viva Beige 80x80 R11

About us

Style
Group
Technology
6mm
Collections

Interiors

MARBLE
La Marmoteca
STONE
La Geoteca
Pietra Viva
Origini
Concept Stone
Burlington Stone

RESIN
I Pigmenti

SOLID COLORS
Chrome

METAL
Oxide

CONCRETE
Make

WOOD
Just Code
Just Nature
Just Color

Decor

Boiserie
Gioia

Technical Info

Technical info

Outdoor

STONE
La Geoteca
Pietra Viva
Origini
Fusion
Burlington Stone
Concept Stone
Antiqua
Soul
Suisse

RESIN
I Pigmenti

METAL
Oxide

CONCRETE
Make
Native
Mesh Up

WOOD
Just Code
Timber
Woodland

INDEX



OUTDOOR STONE

Origini ^(R11)



GRIS ROYAL
8,5MM
80x80 32"x32" G0073704 F 52,50



CRUX GREY
8,5MM
80x80 32"x32" G0073701 F 52,50

Fusion ^(R11)



SAND
20MM
60x60 24"x24" 0013513 F 75,90
60x120 24"x48" 0013514 F 89,50



FOG
20MM
60x60 24"x24" 0013511 F 75,90
60x120 24"x48" 0001821 F 89,50

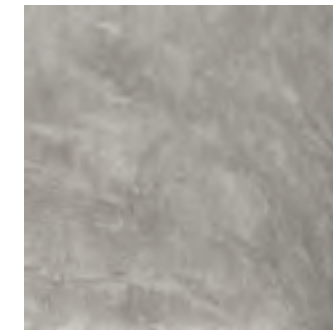

GREIGE
20MM
60x60 24"x24" 0013512 F 75,90
60x120 24"x48" 0001820 F 89,50



Floor
Origini Gris Royal 80x80 R11

About us

- Style
- Group
- Technology
- 6mm
- Collections

Interiors

MARBLE
La Marmoteca

STONE
La Geoteca
Pietra Viva
Origini
Concept Stone
Burlington Stone

RESIN
I Pigmenti

SOLID COLORS
Chrome

METAL
Oxide

CONCRETE
Make

WOOD
Just Code
Just Nature
Just Color

Decor

Boiserie
Gioia

Technical
Info

Technical info

Outdoor

STONE
La Geoteca
Pietra Viva
Origini
Fusion

Burlington Stone
Concept Stone

Antiqua
Soul
Suisse

RESIN
I Pigmenti

METAL
Oxide

CONCRETE
Make

Native
Mesh Up

WOOD
Just Code

Timber
Woodland

INDEX

Burlington Stone ^(R11)

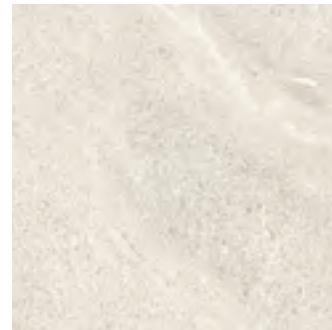

PEARL
8,5MM
60x120 24"x48" G0055440 F 56,50

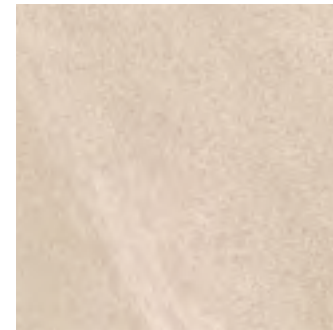

CREAM
8,5MM
60x120 24"x48" G0055441 F 56,50

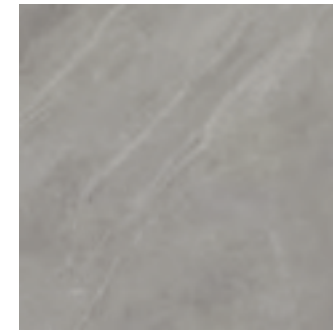

ROCK
8,5MM
60x120 24"x48" G0055442 F 56,50

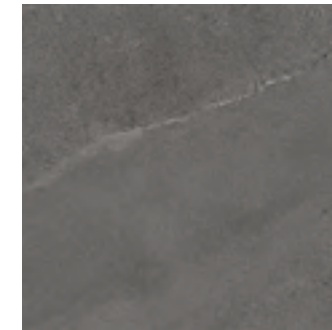

GRAPHITE
8,5MM
60x120 24"x48" G0055443 F 56,50

Concept Stone ^(R11)

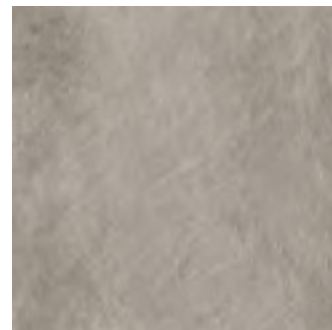

GRIGIO
20MM
80x80 32"x32" G0054123 F 84,50
8,5MM
40x80 16"x32" G0054473 F 51,90

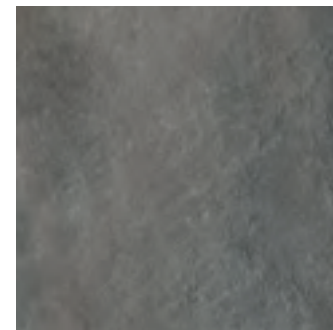

ANTRACITE
20MM
80x80 32"x32" G0054125 F 84,50
8,5MM
40x80 16"x32" G0054475 F 51,90

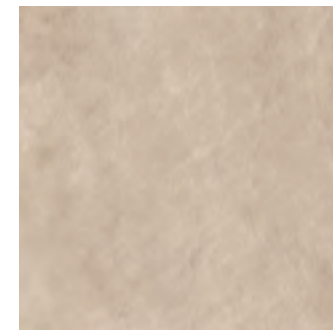

SABBIA
20MM
80x80 32"x32" G0054122 F 84,50
8,5MM
80x80 32"x32" G0054462 F 52,50
40x80 16"x32" G0054472 F 51,90

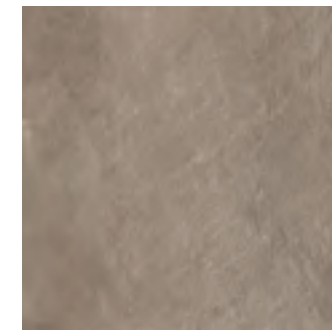

BRUNO MEDIO
20MM
80x80 32"x32" G0054124 F 84,50
8,5MM
80x80 32"x32" G0054464 F 52,50
40x80 16"x32" G0054474 F 51,90

Antiqua ^(R11)



only for 60x60 size



HONEY VEIN
20MM
60x60 24"x24" 0012104 F 56,50
60x90 24"x35,5" 0007180 F 56,50

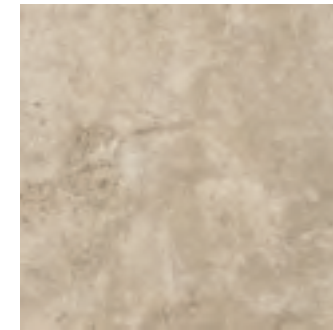

HONEY CROSS
20MM
60x60 24"x24" 0012103 F 56,50
60x90 24"x35,5" 0007181 F 56,50

Soul ^(R11)



only for 60x60 size



SAND
20MM
60x60 24"x24" 0014527 F 75,90
80x80 32"x32" 0012110 F 84,50

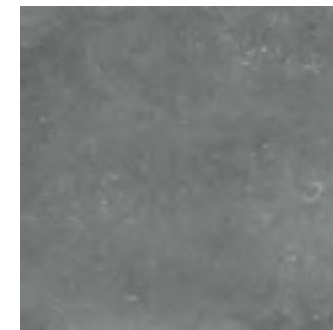

GREY
20MM
60x60 24"x24" 0014528 F 75,90
80x80 32"x32" 0012111 F 84,50

Suisse ^(R11)

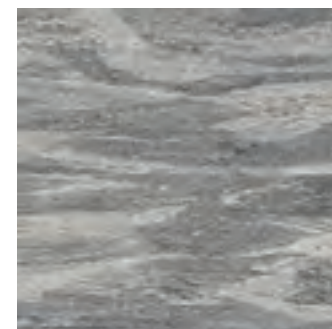

GREY
20MM
60x120 24"x48" 0012295 F 89,50

About us

- Style
- Group
- Technology
- 6mm
- Collections

Interiors

- MARBLE
 - La Marmoteca
- STONE
 - La Geoteca
 - Pietra Viva
 - Origini
 - Concept Stone
 - Burlington Stone

- RESIN
 - I Pigmenti

- SOLID COLORS
 - Chrome

- METAL
 - Oxide

- CONCRETE
 - Make

- WOOD
 - Just Code
 - Just Nature
 - Just Color

Decor

- Boiserie
- Gioia

Technical Info

Technical info

Outdoor

- STONE
 - La Geoteca
 - Pietra Viva
 - Origini
 - Fusion
 - Burlington Stone
 - Concept Stone
 - Antiqua
 - Soul
 - Suisse

- RESIN
 - I Pigmenti

- METAL
 - Oxide

- CONCRETE
 - Make

- Native
- Mesh Up

- WOOD
 - Just Code
 - Timber
 - Woodland

INDEX

I Pigmenti ^{R11}



ASH
8,5MM
120x120 48"x48" 0017464 F 89,50
60x120 24"x48" 0017144 F 69,50



CREAM
8,5MM
120x120 48"x48" 0017466 F 89,50
60x120 24"x48" 0017146 F 69,50



SAND
8,5MM
120x120 48"x48" 0017465 F 89,50
60x120 24"x48" 0017145 F 69,50



Floor
I Pigmenti Cream 120x120 R11

About us

- Style
- Group
- Technology
- 6mm
- Collections

Interiors

- MARBLE**
- La Marmoteca

- STONE**
- La Geoteca
- Pietra Viva
- Origini
- Concept Stone
- Burlington Stone

- RESIN**
- I Pigmenti

- SOLID COLORS**
- Chrome

- METAL**
- Oxide

- CONCRETE**
- Make

- WOOD**
- Just Code
- Just Nature
- Just Color

Decor

- Boiserie
- Gioia

Technical Info

Technical info

Outdoor

- STONE**
- La Geoteca
- Pietra Viva
- Origini
- Fusion
- Burlington Stone
- Concept Stone
- Antiqua
- Soul
- Suisse

- RESIN**
- I Pigmenti

- METAL**
- Oxide

- CONCRETE**
- Make
- Native
- Mesh Up

- WOOD**
- Just Code
- Timber
- Woodland

INDEX



Oxide [®]R11



ALUMINIUM
20MM
80x80 32"x32" G0069350 F 84,50
8,5MM
80x80 32"x32" G0069340 F 56,90

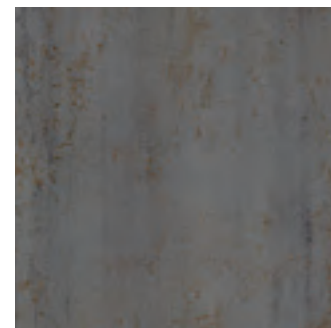

IRON
20MM
80x80 32"x32" G0069352 F 84,50
8,5MM
80x80 32"x32" G0069342 F 56,90

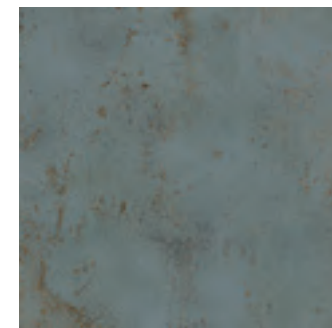

GREEN
20MM
80x80 32"x32" G0069353 F 84,50
8,5MM
80x80 32"x32" G0069343 F 56,90

Make [®]R11

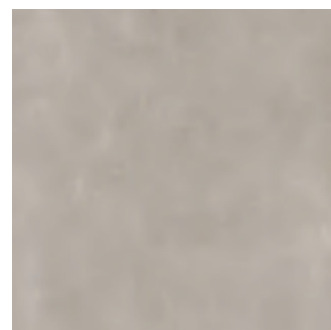

ASH
20MM
80x80 32"x32" G0073052 F 84,50
8,5MM
80x80 32"x32" G0073102 F 52,50

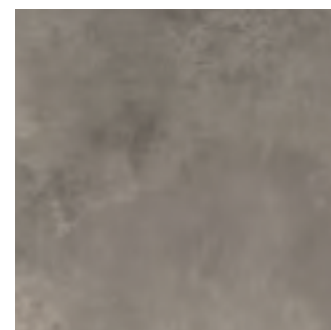

GRIGIO CORTEN
20MM
80x80 32"x32" G0073055 F 84,50
8,5MM
80x80 32"x32" G0073105 F 52,50



ANTRACITE CORTEN
20MM
80x80 32"x32" G0073054 F 84,50
8,5MM
80x80 32"x32" G0073104 F 52,50

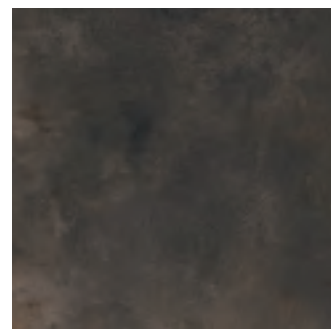

NERO CORTEN
20MM
80x80 32"x32" G0073053 F 84,50



CORDA
8,5MM
80x80 32"x32" G0073101 F 52,50

Floor
Oxide: Green 80x80 R11

About us

Style
Group
Technology
6mm
Collections

Interiors

MARBLE
La Marmoteca

STONE
La Geoteca
Pietra Viva
Origini
Concept Stone
Burlington Stone

RESIN
I Pigmenti

SOLID COLORS
Chrome

METAL
Oxide

CONCRETE
Make

WOOD
Just Code
Just Nature
Just Color

Decor

Boiserie
Gioia

Technical Info

Technical info

Outdoor

STONE
La Geoteca
Pietra Viva
Origini
Fusion
Burlington Stone
Concept Stone
Antiqua
Soul
Suisse

RESIN
I Pigmenti

METAL
Oxide

CONCRETE
Make
Native
Mesh Up

WOOD
Just Code
Timber
Woodland

INDEX

OUTDOOR CONCRETE

Native



SAND
20MM
80x80 32"x32" G0056790 F 84,50
60x60 24"x24" 0013508 F 75,90



MUD
20MM
80x80 32"x32" G0056792 F 84,50
60x60 24"x24" 0013509 F 75,90



SILVER
20MM
80x80 32"x32" G0056791 F 84,50
60x60 24"x24" 0013507 F 75,90

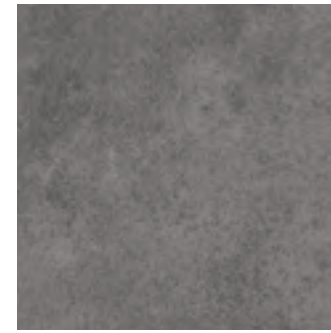

CONCRETE
20MM
80x80 32"x32" G0056793 F 84,50

Mesh Up



ASH
20MM
60x60 24"x24" 0012163 F 75,90

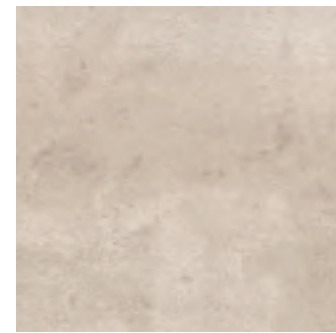

SAND
20MM
60x60 24"x24" 0012164 F 75,90



Floor
Native Silver 80x80, Native Silver Elemento a L 15x80x5

About us

- Style
- Group
- Technology
- 6mm
- Collections

Outdoor

- STONE**
- La Geoteca
- Pietra Viva
- Origini
- Fusion
- Burlington Stone
- Concept Stone
- Antiqua
- Soul
- Suisse

Interiors

- MARBLE**
- La Marmoteca

- STONE**
- La Geoteca
- Pietra Viva
- Origini
- Concept Stone
- Burlington Stone

- RESIN**
- I Pigmenti

- SOLID COLORS**
- Chrome

- METAL**
- Oxide

- CONCRETE**
- Make

- WOOD**
- Just Code
- Just Nature
- Just Color

- RESIN**
- I Pigmenti

- METAL**
- Oxide

- CONCRETE**
- Make
- Native
- Mesh Up

- WOOD**
- Just Code
- Timber
- Woodland

Decor

- Boiserie
- Gioia

Technical Info

Technical info

INDEX



Just Code [®]R11

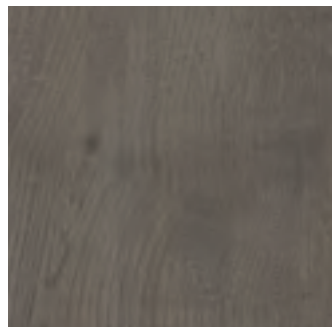

GREIGE
20MM
30x120 12"x48" G0075114 F 89,50
8,5MM
20x120 8"x48" G0075094 F 56,50

Floor
Just Code: Greige 30x120 R11

OUTDOOR WOOD

About us

Style
Group
Technology
6mm
Collections

Interiors

MARBLE
La Marmoteca

STONE
La Geoteca
Pietra Viva
Origini
Concept Stone
Burlington Stone

RESIN
I Pigmenti

SOLID COLORS
Chrome

METAL
Oxide

CONCRETE
Make

WOOD
Just Code
Just Nature
Just Color

Decor

Boiserie
Gioia

Technical Info

Technical info

Outdoor

STONE

La Geoteca
Pietra Viva
Origini
Fusion

Burlington Stone
Concept Stone

Antiqua
Soul
Suisse

RESIN

I Pigmenti

METAL

Oxide

CONCRETE

Make

Native

Mesh Up

WOOD

Just Code

Timber

Woodland

INDEX



Timber [®] R11



MIEL
20MM
30x120 12"x48" 020226912 F 89,50
60x60 24"x24" 0012136 F 75,90



BEIGE
20MM
30x120 12"x48" 020226812 F 89,50
60x60 24"x24" 0012134 F 75,90



NOISETTE
20MM
30x120 12"x48" 020227012 F 89,50
60x60 24"x24" 0012137 F 75,90

Woodland [®] R11



SAND
20MM
30x120 12"x48" 003690 F 89,50

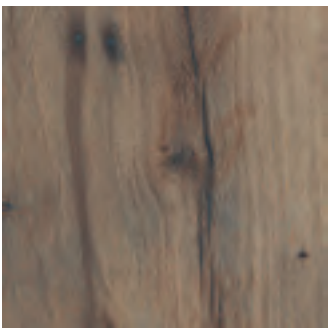

HAVANA
20MM
30x120 12"x48" 003691 F 89,50

About us

- Style
- Group
- Technology
- 6mm
- Collections

Interiors

MARBLE

La Marmoteca

STONE

La Geoteca

Pietra Viva

Origini

Concept Stone

Burlington Stone

RESIN

I Pigmenti

SOLID COLORS

Chrome

METAL

Oxide

CONCRETE

Make

WOOD

Just Code

Just Nature

Just Color

Decor

Boiserie

Gioia

Technical Info

Technical info

Outdoor

STONE

La Geoteca

Pietra Viva

Origini

Fusion

Burlington Stone

Concept Stone

Antiqua

Soul

Suisse

RESIN

I Pigmenti

METAL

Oxide

CONCRETE

Make

Native

Mesh Up

WOOD

Just Code

Timber

Woodland

INDEX

Pezzi speciali per ogni necessità con le nostre soluzioni dedicate

Oltre alle piastrelle, il sistema Gardenia Outdoor contiene un'ampia gamma di pezzi speciali realizzati ad hoc per aiutare i professionisti del gardening e dell'outdoor a trovare soluzioni belle ed efficaci anche nelle realizzazioni più complesse, come gradini e elementi angolari per pedane e scale o le griglie per il bordo piscina, capaci di creare una continuità estetica senza compromessi.

Special pieces for every need
With our dedicated solutions
In addition to tiles, the Gardenia
Outdoor system contains a wide
range of dedicated special pieces
to help garden and outdoor
professionals find beautiful and

effective solutions even in the
most complex installations, such
as steps and corner elements
for platforms and stairs or grilles
for pool sides that create style
continuity with no compromises.

GRIGLIA
Grille

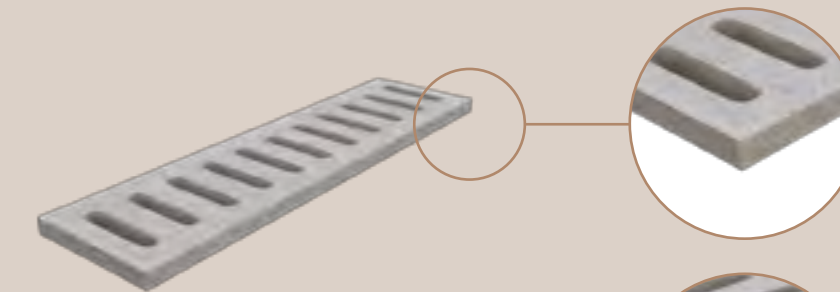

GRIGLIA
ANGOLARE DX/SX
Right/Left corner grille

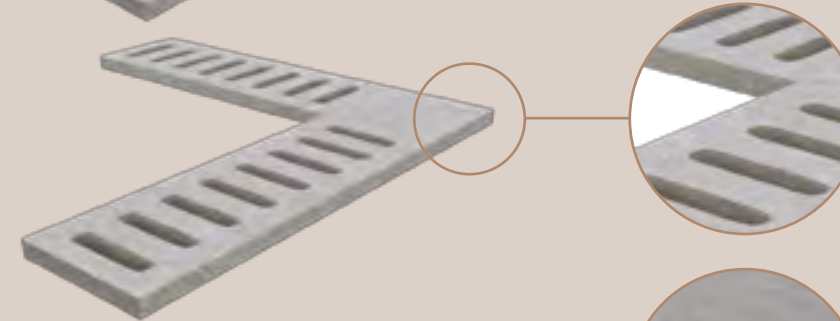

ELEMENTO AD L
L element

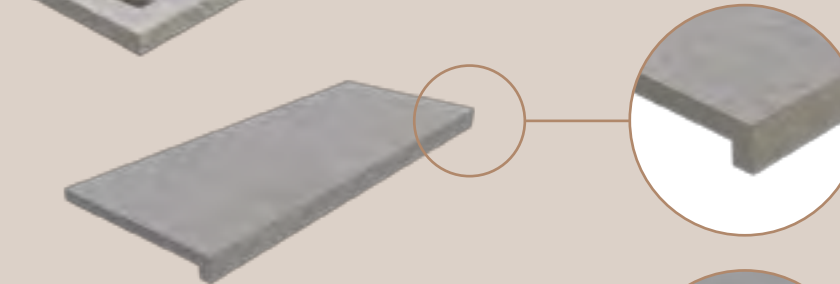

GRADONE BORDO
Step edge

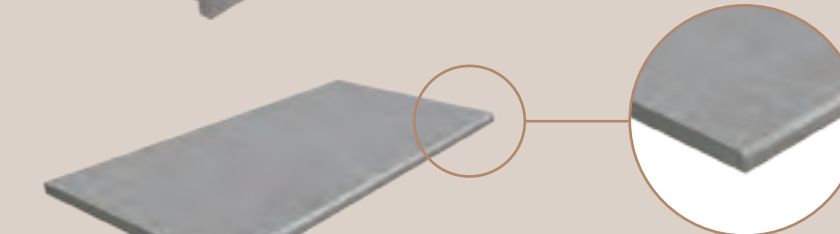

CURVE
Curve

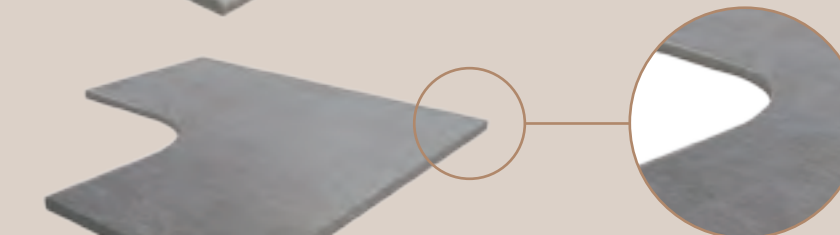

BULLNOSE
Bullnose

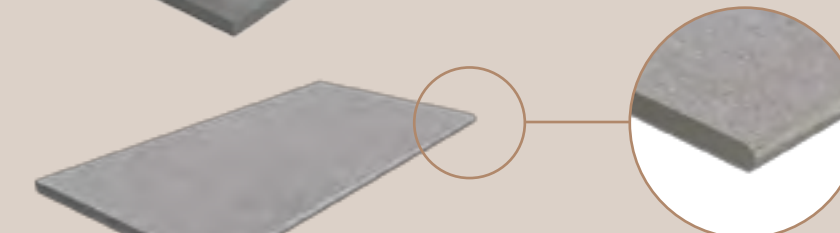

ANGOLARE BULLNOSE
Bullnose

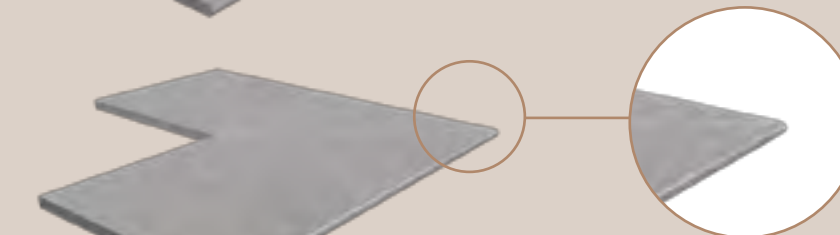

SPECIAL PIECES

About us

Style
Group
Technology
6mm
Collections

Interiors

MARBLE
La Marmoteca

STONE
La Geoteca
Pietra Viva
Origini
Concept Stone
Burlington Stone

RESIN
I Pigmenti

SOLID COLORS
Chrome

METAL
Oxide

CONCRETE
Make

WOOD
Just Code
Just Nature
Just Color

Decor

Boiserie
Gioia

Technical Info

Technical info

Outdoor

STONE
La Geoteca
Pietra Viva
Origini
Fusion

Burlington Stone
Concept Stone
Antiqua
Soul
Suisse

RESIN
I Pigmenti

METAL
Oxide

CONCRETE
Make
Native
Mesh Up

WOOD
Just Code
Timber
Woodland

INDEX

Outdoor 8,5MM - 20MM

PEZZI SPECIALI . SPECIAL TRIMS . PIECES SPECIALES . SONDERSTÜCKE

DISPONIBILI SU RICHIESTA ULTERIORI PEZZI SPECIALI . ADDITIONAL SPECIAL PIECES AVAILABLE ON REQUEST
PIÈCES SPÉCIALES SUPPLÉMENTAIRES SUR COMMANDE . WEITERE SONDERTEILE AUF ANFRAGE MÖGLICH

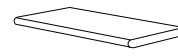
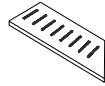

Collection	Colour	Griglia			Griglia Angolare Destra			Griglia Angolare Sinistra			Bullnose		
		15x60 20mm	15x80 20mm	15x120 20mm	15x60 20mm	15x80 20mm	15x120 20mm	15x60 20mm	15x80 20mm	15x120 20mm	30x60 20mm	30x80 20mm	30x120 20mm
La Geoteca	SERENA	0015558			0015563			0015568			0015606		
	VICENZA	0015560			0015565			0015570			0015608		
	BRENNERO	0015559			0015564			0015569			0015607		
	LIMESTONE	0015561			0015566			0015571			0015609		
	PROVENCE	0015562			0015567			0015572			0015610		
	CEPPO DI GRE	0002937			0002941			0002939			0015611		
	BOURGOGNE BEIGE		0016028			0016030		0016032			0016036		
	BOURGOGNE SILVER		0016029			0016031		0016033			0016037		
	TRAV. IVORY VEIN		0016185			0016187		0016189			0016193		
	TRAV. IVORY CROSS		0016186			0016188		0016190			0016194		
Pietra Viva	GREY	0015573	0015346		0015575	0015348	0015577	0015350		0015619	0015443		
	BEIGE	0015574	0015347		0015576	0015349	0015578	0015352		0015620	0015445		
Fusion	GREIGE	0002395			0002401		0002398			0012934			
	FOG	0002396			0002402		0002399			0012935			
	SAND	0015300			0015301		0015302			0015305			
Concept Stone	GRIGIO		0015353		0015357		0015361			0015446			
	ANTRACITE		0015354		0015358		0015362			0015447			
	SABBIA		0015355		0015359		0015363			0015448			
	BRUNO MEDIO		0015356		0015360		0015364			0015449			
Burlington Stone	PEARL												
	CREAM												
	ROCK												
	GRAPHITE												
Suisse	GREY		0012966		0012967		0012968			0012940			
Antiqua	HONEY VEIN	0006351			0006353		0006352			0013047			
	HONEY CROSS	0007186			0007188		0007187			0013048			
Origini	GRIS ROYAL												
	CRUX GREY												
Soul	GREIGE	0015580	0013001		0015582	0013004	0015584	0013007		0015624	0013013		
	GREY	0015579	0013002		0015581	0013005	0015583	0013008		0015623	0013014		
Oxide	ALLUMINIUM		0015337		0015340		0015343			0015466			
	GREEN		0015339		0015342		0015345			0015468			
	IRON		0015338		0015341		0015344			0015467			
Make	CORDA												
	ASH		0015381		0015385		0015389			0015454			
	NERO CORTEN		0015384		0015388		0015392			0015457			
	ANTRACITE CORTEN		0015383		0015387		0015391			0015456			
	GRIGIO CORTEN		0015382		0015386		0015390			0015455			
Native	SAND	0015585	0015393		0015588	0015397	0015591	0015401		0015627	0015462		
	MUD	0015586	0015394		0015589	0015398	0015592	0015402		0015628	0015463		
	SIVER	0015587	0015395		0015590	0015399	0015593	0015403		0015629	0015464		
	CONCRETE		0015396		0015400		0015404			0015465			
Mesh Up	ASH	0002709			0002713		0002711			0013049			
	SAND	0008927			0008929		0008928			0013050			
Just Code	GREIGE			0015705				0015709			0015655		
	MIEL			0015728			0015731			0015734		0015677	
Timber	BEIGE			0015729			0015732			0015735		0015678	
	NOISETTE			0015730			0015733			0015736		0015679	
	SAND			0015719			0015722			0015725		0015671	
Woodland	HAVANA			0015720			0015723			0015726		0015672	
	PRICE LIST		PZ 194,50	PZ 236,50	PZ 290,50	PZ 262,90	PZ 318,90	PZ 360,50	PZ 262,90	PZ 318,90	PZ 360,50	PZ 77,90	PZ 97,90

SPECIAL PIECES

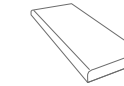
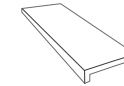

Bullnose Kit Angolare			Elemento ad L						Gradone Bordo			Curve	
160x30 20mm	120x30 20mm	240x30 20mm	15x80x5 20mm	15x60x5 20mm	15x120x5 20mm	15x80x5 8,5mm	15x100x5 8,5mm	15x120x5 8,5mm	30x80 20mm	30x60 20mm	30x120 20mm	60x60 20mm	80x80 20mm
	0015640			0015594		0015764				0015613		0015683	
	0015642			0015596		0015766				0015615		0015685	
	0015641			0015595		0015765				0015614		0015684	
	0015643			0015597		0015767				0015616		0015686	
	0015644			0015598		0015768				0015617		0015687	
	0015645			0002935						0015618		0015688	
0016038			0016034						0016040				0016042
0016039			0016035						0016041				0016043
0016195			0016191						0016197				0016199
0016196			0016192						0016198				0016200
0015510	0015646		0015420	0015599					0015480	0015621		0015689	0015534
0015511	0015647		0015421	0015600					0015481	0015622		0015690	0015535
	0015664			0002392						0015633		0015697	
	0015665			0002393						0015634		0015698	
	0015666			0015303						0015635		0015699	
0015514			0015422			0015773			0015484				0015538
0015515			0015423			0015774			0015485				0015539
0015516			0015424			0015775			0015486				0015540
0015517			0015425			0015776			0015487				0015541
								0015799					
								0015800					
								0015801					
								0015802					
		0015751			0012969						0015650	0015693	
	0015667			0006350						0015636		0015700	
	0015668			0007184						0015637		0015701	
						0015769							
						0015771							
0015513	0015649		0013010	0015602					0015483	0015626		0015692	0015537
0015512	0015648		0013011	0015601					0015482	0015625		0015691	0015536
0015504						0015761			0015489				0015507
0015506						0015763			0015479				0015509
0015505						0015762			0015478				0015508
						0015790							
0015522			0015431			0015787			0015492				0015546
0015525			0015434						0015495				0015549
0015524			0015433						0015494				0015548
0015523			0015432			0015788			0015493				0015547
0015526	0015651		0015435	0015603		0015791			0015496	0015630		0015694	0015550
0015527	0015652		0015436	0015604		0015792			0015497	0015631		0015695	0015551
0015528	0015653		0015437	0015605		0015793			0015498	0015632		0015696	0015552
0015529			0015438			0015794			0015499				0015553
	0015669			0002707						0015638		0015702	
	0015670			0008925						0015639		0015703	
		0015747			0015739			0015804			0015657		
		0015758			0015743						0015680		
		0015759			0015744						0015681		
		0015760			0015745						0015682		
		0015755			0015740						0015674		
		0015756			0015741						0015675		
PZ 317,50	PZ 280,50	PZ 264,50	PZ 133,90	PZ 102,50	PZ 180,50	PZ 70,50	PZ 70,50	PZ 120,50	PZ 97,90	PZ 77,90	PZ 148,50	PZ 209,90	PZ 239,90

About us

Style
Group
Technology
6mm
Collections

Outdoor

STONE
La Geoteca
Pietra Viva
Origini
Fusion
Burlington Stone
Concept Stone

Interiors

MARBLE

La Marmoteca

STONE

La Geoteca
Pietra Viva

Origini

Concept Stone

Burlington Stone

RESIN

I Pigmenti

SOLID COLORS

Chrome

METAL

Oxide

CONCRETE

Make

WOOD

Just Code

Just Nature

Just Color

Decor

Boiserie

Gioia

Technical Info

Technical info

INDEX

Maggiore spessore, Maggiori prestazioni.

GREATER THICKNESS,
HIGHER PERFORMANCE.



**RESISTENTE
AGLI SHOCK TERMICI**
Resistant to thermal shock



**RESISTENTE
AI CARICHI**
Resistant to loads



**RESISTENTE
AI GRAFFI**
Resistant to scratches



**RESISTENTE
ALLE MACCHIE**
Resistant to stains



**RESISTENTE
AGLI ACIDI**
Resistant to acids



**RESISTENTE
AI SALI**
Resistant to salt



**RESISTENTE
AL GELO**
Frostproof



**RESISTENTE
ALL'ACQUA**
Resistant to water



**NON SCOLORA
AL SOLE**
Resistant to fading



ANTISLIP
Anti-slip



**FACILE DA
POSARE**
Easy to install



**FACILE
DA PULIRE**
Easy to clean



**FACILE DA RIMUOVERE
E RIPOSIZIONARE**
Easy to remove and replace



**CONTINUITÀ
INTERNO-ESTERNO**
Indoor-outdoor continuity



IGNIFUGO
fireproof

About us

Style
Group
Technology
6mm
Collections

Interiors

MARBLE
La Marmoteca

STONE
La Geoteca
Pietra Viva
Origini
Concept Stone
Burlington Stone

RESIN
I Pigmenti

SOLID COLORS
Chrome

METAL
Oxide

CONCRETE
Make

WOOD
Just Code
Just Nature
Just Color

Decor

Boiserie
Gioia

Technical Info

Technical info

Outdoor

STONE
La Geoteca
Pietra Viva
Origini
Fusion

Burlington Stone
Concept Stone

Antiqua
Soul
Suisse

RESIN
I Pigmenti

METAL
Oxide

CONCRETE
Make

Native
Mesh Up

WOOD
Just Code
Timber
Woodland

INDEX

Molteplici sistemi di posa

POSA TRADIZIONALE

Ideale per la realizzazione di pavimentazioni carrabili.

TRADITIONAL INSTALLATION

Ideal for floorings that will be driven over by vehicles.

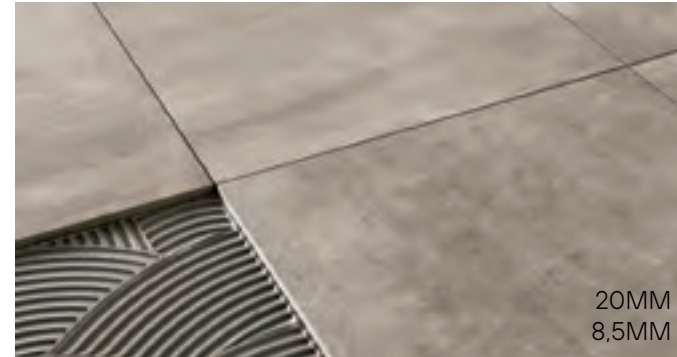

POSA A SECCO SU ERBA

Permette di creare percorsi e camminamenti integrandosi perfettamente nell'ambiente.

DRY INSTALLATION ON GRASS

Enables the creation of paths and walkways that blend in perfectly with the surroundings.



POSA A SECCO SU GHIAIA

Permette il perfetto drenaggio delle acque piovane.

DRY INSTALLATION ON GRAVEL

Enables perfect drainage of rainwater.



POSA A SECCO SU SABBIA

Permette di creare percorsi e camminamenti per spiagge e stabilimenti balneari.

DRY INSTALLATION ON SAND

Ideal for creating paths and walkways on beaches and beach bars.



LAYING

POSA SOPRAELEVATA DA ESTERNO

Il sistema di pavimentazione sopraelevata prevede l'utilizzo di supporti portanti di tipo autolivellante, regolabili oppure fissi che si adattano con semplicità e sicurezza ad ogni tipo di pavimento sottostante. Il sistema permette la realizzazione di piani di posa con altezze variabili, da terra, comprese fra 25 e 270 mm. L'indipendenza della pavimentazione dai supporti garantisce l'assorbimento di eventuali movimenti strutturali. Il sistema sopraelevato non necessita di massetto in cemento e consente una diminuzione del peso sulla struttura portante. Le fughe aperte tra una piastrella ed un'altra consentono un facile deflusso dell'acqua piovana evitando tutti i rischi di accumulo o di ristagno. La presenza dell'intercapedine fra il piano di calpestio e il piano di appoggio favorisce l'aerazione e l'isolamento termico. Questa soluzione permette inoltre il passaggio di impianti e tubazioni nell'intercapedine, e la facile ispezione degli stessi una volta installata la pavimentazione.



OUTDOOR RAISED INSTALLATION

The raised paving system is constructed using fixed or adjustable self-levelling supporting pedestals, which adapt easily and safely to any kind of substrate. The system is able to construct paved surfaces at heights from 25 to 270 mm above the ground. Since the paving is not rigidly connected to its pedestals, any settling within the structure is absorbed. The raised paving system does not require a concrete screed and reduces the weight on the substrate. The open joints between tiles facilitate rainwater run-off, avoiding all risks of flooding or standing water. The cavity between the paving surface and substrate improves aeration and thermal insulation. What's more, utility systems and pipes can be housed in the cavity and are easily inspected once the paving has been installed.

SISTEMA DI PAVIMENTAZIONE SOPRAELEVATA PER ESTERNI

Outdoor raised laying system

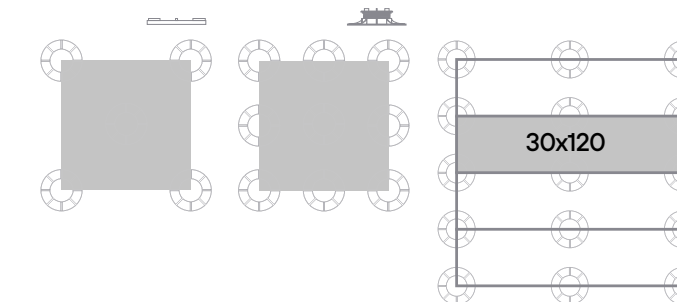

Raised
TiL<2
3÷4 Pz/Sqm

Raised
2-10cm
6÷7 pz/sqm

Raised Pedestal
System
5÷6 pz/sqm

MULTIPLE LAYING SYSTEMS

About us

Style
Group
Technology
6mm
Collections

Interiors

MARBLE
La Marmoteca

STONE
La Geoteca
Pietra Viva
Origini
Concept Stone
Burlington Stone

RESIN
I Pigmenti

SOLID COLORS
Chrome

METAL
Oxide

CONCRETE
Make

WOOD
Just Code
Just Nature
Just Color

Decor

Boiserie
Gioia

Technical
Info

Technical info

Outdoor

STONE

La Geoteca
Pietra Viva
Origini
Fusion

Burlington Stone
Concept Stone

Antiqua
Soul
Suisse

RESIN

I Pigmenti

METAL

Oxide

CONCRETE

Make

Native

Mesh Up

WOOD

Just Code

Timber

Woodland

INDEX

Outdoor 8,5MM - 20MM

CLASSIFICAZIONE SECONDO LE NORME EN 14411/G Bia - EN14411 Bia UGL
CLASSIFICATION IN THE ACCORDANCE WITH . CLASSIFICATION SELON LES NORMES . EINSTUFUNG NACH DEN NORMEN

CARATTERISTICHE TECNICHE DI SUPPORTO

PHYSICAL PROPERTIES OF THE TILE'S BODY . CARACTÉRISTIQUES TECHNIQUES DU CORP DU CARREAU . TECHNISCHE EIGENSCHAFTEN DES SCHERBENS

	GRES PORCELLANATO PORCELAIN GRES CERAME FEINSTEINZEUG	NORMA STANDARD NORME NORM	VALORE PRESCRITTO DALLE NORME VALUES REQUIRED BY THE STANDARD VALEUR PRESCRIPTE PAR LES NORMES NORMVORGABE	(UNI EN 14411 BIA)	VALORE GARDENIA ORCHIDEA GARDENIA ORCHIDEA VALUES VALEUR GARDENIA ORCHIDEA GARDENIA ORCHIDEA WERTE
	Lunghezza e larghezza Length and width / Longueur et largeur Länge und Breite	UNI EN ISO 10545/2	± 0,6% (max ± 2mm)		± 0,6% (max ± 2mm)
	Spessore Thickness / Epaisseur Stärke	UNI EN ISO 10545/2	± 5% (max ± 0,5mm)		± 5% (max ± 0,5mm)
	Rettilineità spigoli Warpages of edges / Réctitude des arêtes Geradheit der Kanten	UNI EN ISO 10545/2	± 0,5% (max ± 1,5mm)		± 0,5% (max ± 1,5mm)
	Ortogonalità Wedging / Ortonnalité Rechtwinkligkeit	UNI EN ISO 10545/2	± 0,5% (max ± 2mm)		± 0,5% (max ± 2mm)
	Planarità Flatness / Planéité Planität	UNI EN ISO 10545/2	± 0,5% (max ± 2mm)		± 0,5% (max ± 2mm)
	Assorbimento % d'acqua Water absorption / Absorption d'eau % Wasseraufnahme %	UNI EN ISO 10545/3	≤ 0,5%		≤ 0,5%
	Resistenza alla flessione Bending strength / Résistance à la flexion Biegezugfestigkeit	UNI EN ISO 10545/4	≥ 35 N/mm ²		≥ 35 N/mm ²
	Resistenza al gelo Frost resistance / Résistance au gel Frostbeständigkeit	UNI EN ISO 10545/12			Nessuna alterazione No alteration / Aucune altération Keine Veränderung
	Resistenza alla flessione Bending strength / Résistance à la flexion Biegezugfestigkeit	UNI EN ISO 10545/4	Richiesta Request / Demande Verlangt		Nessuna alterazione No alteration / Aucune altération Keine Veränderung
	Resistenza all'abrasione profonda Resistance to deep abrasion / Résistance a l'abrasione profonde Tiefenabrieb	UNI EN ISO 10545/6	≤ 175 mm ³		≤ 175 mm ³

About us

Style
Group
Technology
6mm
Collections

Outdoor

STONE
La Geoteca
Pietra Viva
Origini
Fusion
Burlington Stone
Concept Stone
Antiqua
Soul
Suisse

Interiors

MARBLE
La Marmoteca

STONE
La Geoteca
Pietra Viva
Origini
Concept Stone
Burlington Stone

RESIN
I Pigmenti

METAL
Oxide

RESIN
I Pigmenti

SOLID COLORS
Chrome

CONCRETE
Make
Native
Mesh Up

METAL
Oxide

WOOD
Just Code
Timber
Woodland

CONCRETE
Make

WOOD
Just Code
Just Nature
Just Color

Decor

Boiserie
Gioia

Technical
Info

Technical info

INDEX

INFO TECNICHE

TECHNICAL INFORMATION



Consigli di posa e pulizia

INSTALLATION AND
CLEANING ADVICE



Caratteristiche tecniche

TECHNICAL
CHARACTERISTICS



Ecosostenibilità e certificazioni

ECO-SUSTAINABILITY
AND CERTIFICATIONS

About us

Style
Group
Technology
6mm
Collections

Interiors

MARBLE
La Marmoteca

STONE
La Geoteca
Pietra Viva
Origini
Concept Stone
Burlington Stone

RESIN
I Pigmenti

SOLID COLORS
Chrome

METAL
Oxide

CONCRETE
Make

WOOD
Just Code
Just Nature
Just Color

Decor

Boiserie
Gioia

Technical Info

Technical info

Outdoor

STONE
La Geoteca
Pietra Viva
Origini
Fusion
Burlington Stone
Concept Stone
Antiqua
Soul
Suisse

RESIN
I Pigmenti

METAL
Oxide

CONCRETE
Make
Native
Mesh Up

WOOD
Just Code
Timber
Woodland

INDEX

Logistica nuovi sistemi di imballo

LOGISTICS NEW PACKAGING SYSTEMS

L'innovazione della gamma GARDENIA SLABS si esprime anche attraverso la parte logistica del progetto. Gardenia rivoluziona il sistema di imballaggio delle lastre ed è a oggi l'unica azienda che ha portato il sistema a cavalletto impilabile alla dimensione di cm 75x284x147,5 (lastre 120x280), 75x168x109 (lastre 80x160) e 75x26x200 (lastre 26x200).

Questi i principali vantaggi offerti:

- essendo impilabile permette di ottimizzare gli spazi all'interno dei magazzini.*
- la profondità di 75 cm consente di sfruttare a pieno il volume di carico dei container (3 pallets ne occupano perfettamente la larghezza).
- Il posizionamento verticale del prodotto garantisce una maggiore protezione delle lastre durante le fasi di trasporto.
- facilita le operazioni sul cantiere in quanto le lastre si trovano già posizionate in verticale, il materiale è facilmente ispezionabile e removibile per l'installazione.
- le dimensioni complessive del cavalletto consentono maggiori spazi di manovra all'interno dei locali di posa rispetto alle casse tradizionali e agevolano il sollevamento del materiale mediante mezzi meccanici (gru-montacarichi).
- è caratterizzato da un sistema di regettatura che consente di liberare anche 1 solo collo alla volta, senza compromettere la stabilità del materiale che rimane sul pallet, evitando così il rischio di rotture. Le lastre dovranno essere liberate rispettando la sequenza opposta rispetto a quella con cui sono state confezionate, quindi iniziando dall'ultimo collo regettato.

Innovation in the GARDENIA SLABS range is also reflected in the project's logistics. Gardenia has revolutionised the packaging of ceramic slabs and is the only company to have expanded the stacking rack pallet system to the 75x284x147,5 (slabs 120x280), 75x168x109 (slabs 80x160) and 75x26x200 (slabs 26x200) cm size.

This has the following advantages:

- stacking optimises the use of space in warehouses.*
- the 75 cm depth enables full use of container load space (3 pallets fit perfectly side by side). The vertical positioning of the product better protects the slabs during shipping.
- it facilitates work on site, since the slabs are already positioned vertically, making the material easy to inspect and remove for installation.
- the overall size of the rack pallet provides greater space for manoeuvring in the installation area in comparison with conventional crates, and also makes it easier to lift the slabs mechanically (with a crane or lift).
- the rack pallet system employs strapping which allows the user to remove a single package at a time without affecting the stability of the other packages on the pallet, thus minimising the risk of breakage. The slabs must be released from the packaging by reversing the packaging sequence, i.e. starting with the last package to have been strapped on.

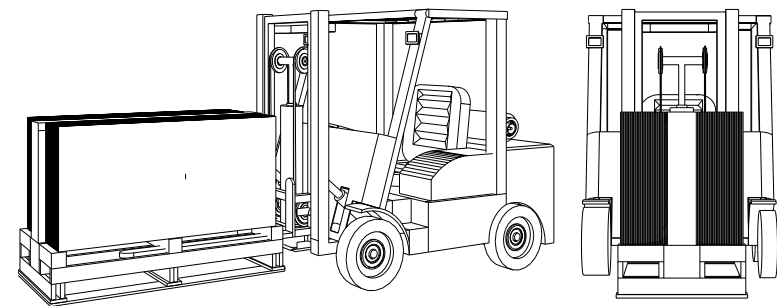

Modalità di trasporto consigliata per ottenere la massima visibilità.

Recommended transport system for maximum visibility.

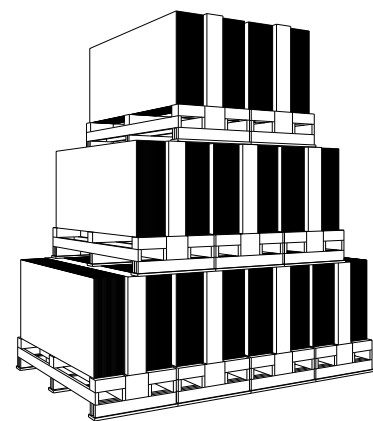

*Esempio di sovrapposizione del rack pallet con il formato 80x160.

*Example of stacked rack pallets with the 80x160 cm size.

Carico su Camion
Truck loading

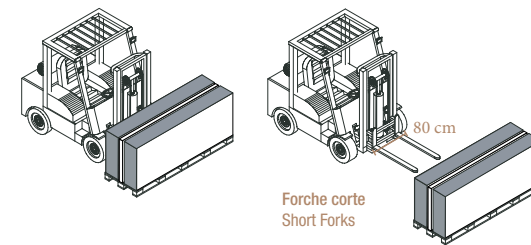

Forche corte
Short Forks

Cavalletto impilabile
Stackable Rack pallet

Formati Size:
120x280
80x160
26x200

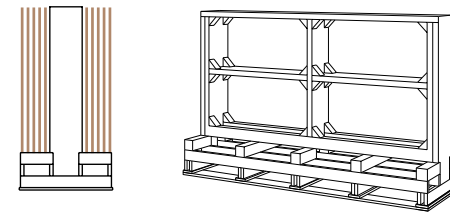

Cavalletto
Rack pallet
Impilabile Stackable

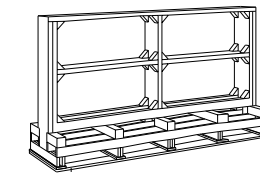

Ingombro Size
75x284x147,5
(120x280 RETT)
€ 200,00

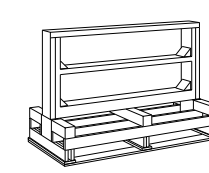

Ingombro Size
75x168x109
(80x160 RETT)
€ 120,00

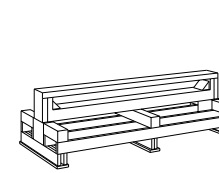

Ingombro Size
75x50x200
(26x200 RETT)
€ 60,00

Pallet per ordini al venduto
Picking order pallet

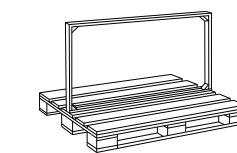

Ingombro Size
80x130x60
(60x120 30x120 80x80)
VERTICALE/VERTICAL

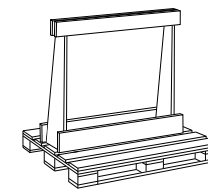

Ingombro Size
80x130x120
(120x120)
VERTICALE/VERTICAL
€ 40,00

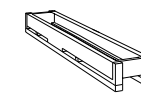

Ingombro Size
34x217x37
(26x200 RETT)

Su richiesta imballo standard con scatole orizzontali senza addebito.
Standard packaging with laying boxes possible without charges.

Carico su Container
Container loading

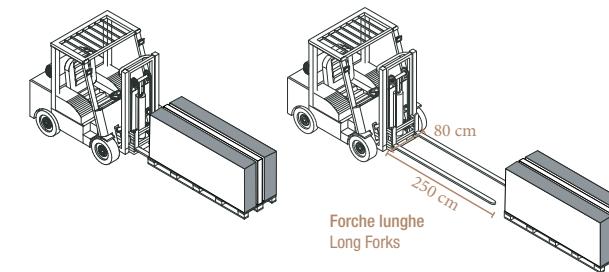

Forche lunghe
Long Forks

Cassa
Crate
Impilabile Stackable

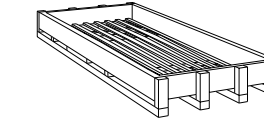

Ingombro Size 144x291x34
(120x280 LUX)
€ 150,00

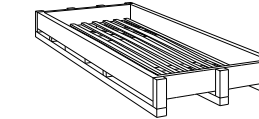

Ingombro Size 144x291x24
(120x280)
€ 90,00
quantità massima 5 lastre
maximum quantity 5 slabs

Cavalletto per containers
Rack pallet for containers
Non impilabile Not stackable

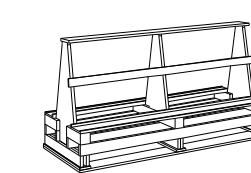

Ingombro Size
75x288x161
(120x280 RETT/LUX)
€ 295,00

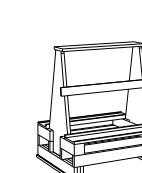

Ingombro Size
75x130x149
(120x120 RETT./LUX)

Pallet con sponde
Pallet with sides
Impilabile Stackable

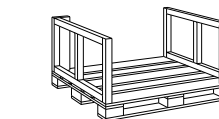

Ingombro Size
122x143x70
(120x120 LUX)
€ 40,00

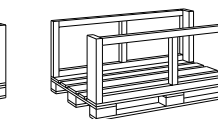

Ingombro Size
99x162x70
(80x160 LUX)
€ 70,00

About us

Style
Group
Technology
6mm
Collections

Interiors

MARBLE
La Marmoteca
Pietra Viva
Origini
Concept Stone
Burlington Stone

RESIN
I Pigmenti

SOLID COLORS
Chrome

METAL
Oxide

CONCRETE
Make

WOOD
Just Code
Just Nature
Just Color

Decor

Boiserie
Gioia

Technical Info

Technical info

Outdoor

STONE
La Geoteca
Pietra Viva
Origini
Fusion
Burlington Stone
Concept Stone
Antiqua
Soul
Suisse

RESIN
I Pigmenti

METAL
Oxide

CONCRETE
Make

Native
Mesh Up





WOOD
Just Code
Timber
Woodland

INDEX

Imballi



PACKAGING

GRES PORCELLANATO PORCELAIN TILES

F.to nominale Nominal size	Finitura Finish	▼ ▲	F.to reale (mm) Work size (mm)	Imballo Packing	Pz/ Pcs/ Box	Mq/ Scat. Sqm/ Box	Kg/ Mq Kg/ Sqm	Kg/ Scat. Kg/ Box	Scat./ Imb. Box/ Pack.	Pz Totali Pcs Total	Mq totali Sqm total	Kg Imb. Kg Packing	Kg Totali Kg Total	Prezzo Imb. Packing price	Dimens, Imballo Packing sizes
120x280 48"x112"	Rett.	6	1194x2800	cassa crate	-	-	15	-	-	20	67,2	95	1.105	€ 150,00	 P.75 L.330 H.201
				cavalletto T-frame	-	-	15	-	-	36	120,96	120	1.935	€ 220,00	 P.75 L.330 H.201
				cavalletto T-frame	-	-	15	-	-	36	120,96	120	1.935	€ 220,00	 P.75 L.288 H.161
				cavalletto container	-	-	15	-	-	36	120,96	165	1.980	€ 295,00	 P.75 L.288 H.161
30x30 12"x12"	Rett.	8,5	297x297	pallet	13	1,17	19,50	22,80	40	520	46,80	20	932	-	
10x60 4"x24"	Rett.	8,5	97,6X596	pallet	12	0,72	19,50	14,00	50	600	36,00	20	720	-	
30x60 12"x24"	Rett.	8,5	297x596	pallet	6	1,08	19,50	21,00	40	240	43,20	20	860	-	
60x60 24"x24"	Rett.	8,5	596x596	pallet	3	1,08	19,50	21,00	40	120	43,20	20	860	-	
60x60 24"x24"	Rett.	20	596x596	pallet	2	0,72	45,30	32,60	30	60	21,60	22	1.000	-	
60x90 24"x35"	Rett.	20	596x895	pallet	1	0,54	45,30	24,50	32	32	17,28	20	804	-	
60x90 mix floor 24"x35"	Rett.	8,5	3 pezzi	pallet	3	1,08	19,50	21,00	22	66	23,76	20	482	-	
5x120 2"x48"	Rett.	8,5	48x1194	pallet	6	0,36	19,50	7,00	63	378	22,68	20	461	-	
60x120 24"x48"	Rett.	6	596x1194	pallet con tavole	3	2,16	15,00	32,40	27	81	58,32	20	895	-	
60x120 24"x48"	Rett.	8,5	596x1194	pallet con tavole	2	1,44	19,50	28,00	30	60	43,20	20	860	-	
60x120 24"x48"	Rett.	20	596x1194	pallet con tavole	1	0,72	45,30	32,60	30	30	21,60	20	998	-	
120x120 48"x48"	Rett.	6	1194x1194	pallet con sponde pallet with sides	2	2,88	15,00	43,20	24	48	69,12	40	1.077	-	
120x120 48"x48"	Rett.	8,5	1194x1194	pallet con sponde pallet with sides	2	2,88	19,50	56,10	18	36	51,84	40	1.050	-	
40x80 16"x32"	Rett.	8,5	397,62x797,25	pallet	3	0,96	19,50	18,70	30	90	28,80	20	581	-	
80x80 32"x32"	Rett.	8,5	797,25x797,25	pallet	2	1,28	19,50	24,90	48	96	61,44	20	1.215	-	
80x80 32"x32"	Rett.	20	797,25x797,25	pallet	1	0,64	45,30	28,90	35	35	22,40	20	1.032	-	

TECHNICAL INFORMATION

GRES PORCELLANATO PORCELAIN TILES

F.to nominale Nominal size	Finitura Finish	▼ ▲	F.to reale (mm) Work size (mm)	Imballo Packing	Pz/ Pcs/ Box	Mq/ Scat. Sqm/ Box	Kg/ Mq Kg/ Sqm	Kg/ Scat. Kg/ Box	Scat./ Imb. Box/ Pack.	Pz Totali Pcs Total	Mq totali Sqm total	Kg Imb. Kg Packing	Kg Totali Kg Total	Prezzo Imb. Packing price	Dimens, Imballo Packing sizes
26,5x180 10,5"x72"	Rett.	8,5	264,7x1798,0	pallet con gabbia	3	1,43	19,50	27,80	42	126	60,06	60	1.228	€ 68,00	 P.184 L.91 H.54
80x180 32"x72"	Rett.	8,5	798,0x1798,0	pallet con gabbia	2	2,88	19,50	56,10	17	34	48,96	60	1.014	€ 68,00	 P.184 L.91 H.54
100x100 40"x40"	Rett.	8,5	998,0x998,0	pallet con sponde pallet with sides	2	2,00	19,50	39,00	24	48	48,00	40	976	€ 35,00	 P.99 L.162 H.70
20x120 8"x48" (Just Code)	Rett.	8,5	198,0x1198,0	pallet con tavole	6	1,44	18,85	27,20	36	216	51,84	20	999	-	
20x120 8"x48" (Eff. Legno)	Rett.	8,5	199,0x1194,0	pallet con tavole	6	1,44	18,85	27,20	36	216	51,84	20	999	-	
20x120 8"x48"	Rett.	8,5	197,3x1194	pallet con tavole	6	1,44	18,85	27,20	36	216	51,84	20	999	-	
30x120 12"x48"	Rett.	8,5	298,0x1198,0	pallet con tavole	3	1,08	19,50	21,00	36	108	38,88	20	776	-	
30x120 12"x48"	Rett.	20	296,0x1195,5	pallet con tavole	2	0,72	45,30	32,60	30	60	21,60	20	998	-	

DECOR

F.to nominale Nominal size	Finitura Finish	▼ ▲	F.to reale (mm) Wor k size (mm)	Imballo Packing	Pz/Scat. Pcs/Box	Mq/Scat. Sqm/Box	Kg/Mq Kg/Sqm	Kg/Scat. Kg/Box	Scat./Imb. Box/Packing	Pz Totali Pcs Total	Mq totali Sqm total	Kg Imb. Kg Packing	Kg Totali Kg Total	Prezzo Imb. Packing price
60x120 24"x48" (Gioia: Tinte Unite)	Rett.	7	596x1194	pallet	2	1,44	14,00	20,00	40	80	57,60	40	840	-
60x120 24"x48" (Gioia Decorati Gres porcellanato)	Rett.	7	596x1194	pallet	2	1,44	16,50	24,00	32	64	46,08	40	808	-

L'unità minima di vendita per tutti gli articoli (fondi, decori e pezzi speciali) è la scatola completa. I dati relativi agli imballi sono aggiornati al momento della stampa del catalogo e pertanto possono subire variazioni nel corso del tempo. Pezzi speciali e decori per effetto delle lavorazioni, possono presentare variazioni di tonalità.

The minimum sales quantity for all items (plain tiles, decorations and special trims) is one full box. Data referring to packaging have been update at time of printing; the actual data may be slightly different. Due to working process special trims and decors, may show variation in tonality.

Le caratteristiche di superficie e le tonalità dei prodotti ceramici illustrati in questo catalogo sono da ritenersi puramente indicative. Optical features and color shades of ceramic materials illustrated in this catalogue are to be regarded as mere indications.

About us

Style
Group
Technology
6mm
Collections

Interiors

MARBLE
La Marmoteca
STONE
La Geoteca
Pietra Viva
Origini
Concept Stone
Burlington Stone

RESIN
I Pigmenti

SOLID COLORS
Chrome

METAL
Oxide

CONCRETE
Make

WOOD
Just Code
Just Nature
Just Color

Decor

Boiserie
Gioia

Outdoor

STONE
La Geoteca
Pietra Viva
Origini
Fusion
Burlington Stone
Concept Stone
Antiqua
Soul
Suisse

RESIN
I Pigmenti

METAL
Oxide

CONCRETE
Make
Native
Mesh Up

WOOD
Just Code

METAL
Timber

Woodland

IN
D
EX

Technical Info

Technical info

CONDIZIONI GENERALI DI VENDITA

1) APPROVAZIONE Gli ordini pervenutici sono per noi impegnativi solo dopo la nostra conferma scritta.
2) CONSEGNA La consegna del materiale s'intende avvenuta a carico effettuato presso i nostri magazzini. Tutti i rischi di trasporto, compresi ammanchi, rotture, deterioramenti e manomissioni sono a carico del Committente anche se il prezzo pattuito è franco di porto, FOB o C&F. Gli accordi con spedizionieri s'intendono sempre conclusi in nome e per conto del Committente che fin d'ora ratifica ed accetta l'operato.
3) TERMINI DI CONSEGNA I termini di consegna hanno carattere indicativo, eventuali ritardi nelle consegne, interruzioni, sospensioni totali o parziali delle forniture non daranno diritto ad indennizzi o risarcimento danni.
4) CONTESTAZIONI La garanzia della merce è limitata al solo, ed esclusivamente, materiale di prima scelta, con una tolleranza del 5% circa. Le differenze di tonalità non potranno essere denunciate come vizio del materiale. Eventuali reclami in merito alla qualità, tipo del materiale, dovranno pervenirci entro 8 giorni dalla data di consegna. Il compratore s'impegna a tenere a disposizione le partite contestate così da consentire il controllo dei difetti denunciati, in ogni caso la posa in opera ci esonererà da qualsiasi responsabilità. Eventuali vizi o difetti di qualità della merce, ove siano denunciati nei termini di legge ed accertati o riconosciuti, danno diritto solamente alla sostituzione dei materiali difettosi, a condizione della preventiva restituzione delle merci contestate, e, su autorizzazione scritta dell'operazione di resa, restando tassativamente esclusi la risoluzione del contratto e qualsiasi risarcimento danni.
5) DIMENSIONI E TONALITA' I nostri materiali sono da classificarsi fra i prodotti cotti ad alta temperatura e come tali possono presentare differenze tra le dimensioni dichiarate e quelle effettivamente consegnate. Così si dica per le differenze di tono all'interno della medesima partita. Quanto sopra perciò non potrà essere oggetto di reclamo da parte del committente.
6) IMBALLO E QUANTITA' Il buono stato degli imballi e della loro confezione nonché della quantità consegnata resta accertato con l'accettazione della merce da parte del vettore. Questi, firmando la Bolla di Accompagnamento, si rende responsabile del buono stato del materiale e del quantitativo. Il compratore nel caso si verifichino rotture ed ammanchi dovrà chiedere eventuali danni o risarcimenti al vettore.
7) RESI Per nessuna ragione l'acquirente potrà restituire il materiale senza nostra espressa preventiva autorizzazione scritta e tutte le spese sono a carico del Committente.
8) ANNULLI Non verranno accettati annullamenti di ordini se il materiale è già stato prodotto o se è già stata avviata la lavorazione e molto più se è già stata effettuata la spedizione. L'annullamento dell'ordine comporterà in ogni caso l'obbligo da parte del Committente di pagare l'intera fornitura. Nel caso che sia fattibile l'accettazione dell'annullamento il Cliente sarà tassativamente tenuto a rifondere tutte le spese sostenute dal produttore fino a quel momento.
9) PREZZI I prezzi riportati sui nostri listini non sono per noi impegnativi. Ci riserviamo il diritto di modificarli prima dell'accettazione dell'ordine.
10) PAGAMENTI I pagamenti devono essere effettuati solo presso la nostra sede. Il ritardo di 10 giorni di ogni pagamento dovuto, o la mancata copertura nel termine stesso di un titolo di credito, girato o ceduto o emesso dal committente, costituisce grado di insolvenza. In tal caso sarà nostra facoltà sospendere le forniture ed annullare ogni rapporto in corso; immediatamente esigerò l'integrale pagamento di ogni rapporto in corso; esigere l'integrale pagamento di ogni nostro credito ed agire giudizialmente al riguardo, in via esecutiva o cautelare nonché per il risarcimento danni; in ogni caso, trascorsi 10 giorni da ogni pagamento dovuto, siamo autorizzati a emettere tratta a vista con spese senza preavviso. Inoltre decorreranno sul debito scaduto gli interessi moratori annui calcolati nella misura del tasso "prime rate" corrente maggiorato di 5 punti percentuali.
11) UNITÀ MINIMA DI VENDITA Non si effettuano vendite inferiori alla scatola.
12) RISERVATO DOMINIO Il materiale anche se spedito e regolarmente fatturato resta di nostra proprietà fino al pagamento totale della fornitura medesima anche in caso di passaggio o vendita terzi.
13) FORO COMPETENTE Per qualsiasi controversia sarà esclusivamente competente il foro di Modena.

GENERAL SALES TERMS AND CONDITIONS

1) APPROVAL All orders that we receive are considered to be binding only after our written confirmation has been issued.
2) DELIVERY The materials are intended as delivered upon loading at our warehouses. All transport risks, including missing pieces, breakage, deterioration and tampering are the sole responsibility of the Client, even if the price agreed upon is carriage free, FOB, or C&F. Agreements with forwarding agents are intended as concluded in the name of and on behalf of the Client, who hereby confirms and accepts their terms and conditions.
3) TERMS OF DELIVERY The terms of delivery are indicative, eventual delays in the delivery, interruptions, or total or partial suspensions of the supply do not allow any right to indemnification or compensation for damages.
4) DISPUTES The guarantee of the goods is limited only and exclusively to first rate materials, with a tolerance of approximately 5%. The difference in shades of colour cannot be declared as a material defect. Eventual complaints regarding the quality or the type of material must be submitted within 8 days from the date of delivery. The purchaser agrees to make available the disputed lots in order that the declared defects may be controlled. In any case, the installation exonerates the manufacturer from any liability. Eventual manufacturing defects or quality defects in the goods, where declared according to law and ascertained or recognized, give right only to the replacement of the defective materials, provided that the goods have been returned previously and the written authorization of the return operation has been issued, the resolution of the contract as well as any compensation for damages is peremptorily waived and excluded.
5) DIMENSIONS AND TONALITY Our materials are classified as products fired at high temperatures and as such may present discrepancies between the dimensions declared and those actually delivered. The same applies for differences in colours within the same production lot. Therefore, the client may not present a dispute regarding abovementioned product characteristic.
6) PACKAGING AND QUANTITY The good condition of the packaging and cartons as well as the quantity delivered are verified upon acceptance of the goods by the forwarding agent. The forwarding agent declares himself responsible for the condition and quality of the goods upon signing the packing list. In case of missing pieces of breakage, the purchaser must ask for eventual damages or compensation from the forwarding agent.
7) RETURNS For no reason will purchaser be able to return the material without our express prior written authorization and all the costs of the return will be assumed by the Client.
8) CANCELLATIONS Order cancellations will not accepted if the material has already been produced or if the production has already begun, and more so if the materials have already been shipped. In any case, the Client is obliged to pay the entire sum of the supply if the order is cancelled. If the acceptance of the cancellation is feasible, the Client will be peremptorily obliged to reimburse all the expenses sustained by the producer up to that moment.
9) PRICES The prices on our price list are not binding. We reserve the right to modify prices before accepting an order.
10) PAYMENT Payments must be made only in our main office. Delays of more than 10 days for each payment due or insufficient funds during the same term of a check, whether endorsed of transferred, or issued by the customer, constitutes bad debt. In this case, we reserve the right to suspend supply and annual all ongoing relations, immediately require total payment of all ongoing relations; require total payment of each credit and to make legal recourse, whether executive or precautionary, as well as request compensation for damages. In any case, after 10 days any payment due,we are authorized to issue an on-sight draft with expenses without notice. Furthermore, annual penalty interest will accumulate on the expired debt to be calculated according to the current "Prime rate" plus five (%) percentage points.
11) MINIMUM PACKAGING REQUIREMENTS Sales of less than one box will not be allowed.
12) SELLER'S LIEN The material, even is shipped and regularly invoiced, remains our property until payment in full of the invoice itself, even in case of passage or sale to third parties.
13) PLACE OF JURISDICTION For any eventual dispute, the only place of jurisdiction will be the Modena Tribunal.

SERVIZI DI LOGISTICA

ANNULLAMENTO ORDINI: per l'annullamento autorizzato di ordini di materiali già consegnati al nostro deposito e per resi autorizzati, verrà addebitato il 15% del valore imponibile, con fisco minimo di 50 €, per contributo spese di trasporto e riselezione.

ORDINI DI PICCOLE QUANTITA': per ordini di fondi, gradini o battiscopa inferiori ai 5 colli complessivi verrà richiesto un contributo di spese di packaging e movimentazione pari a 20 €.

SPALLETTIZZATO: per ordini di metratura inferiore al pallet completo verrà applicata una maggiorazione pari a 1,80 /m2 e 3,00 /m2 per la serie Outdoor

CONSEGNE URGENTI: per preparazione di ordini entro le 24 ore, con un limite massimo di 2 articoli totali, verrà addebitata una maggiorazione di 30 € netta fissa.

IMBALLAGGI

ADDEBITO: Gli imballaggi speciali saranno addebitati al costo visibile nella tabella riepilogativa.

RESO: gli imballi dei formati 160x320 e 120x280 potranno essere resi e riaccreditati a condizione che vengano restituiti in buono stato. Nulla potrà essere riconosciuto per imballi non più riutilizzabili o di formati di dimensioni inferiori.

RESO: gli imballi dei formati 160x320 e 120x280 potranno essere resi e riaccreditati a condizione che vengano restituiti in buono stato.

Nulla potrà essere riconosciuto per imballi non più riutilizzabili o di formati di dimensioni inferiori.

LOGISTICS SERVICES

ORDER CANCELLATION: for the authorized cancellation of orders for materials already delivered to our warehouse, and for authorized returns, 15% of the taxable value will be charged, with a fixed minimum of € 50, for transport and reselection costs.

SMALL QUANTITY ORDERS: for orders of solid colour basic tiles, treads or skirting boards amounting to less than 5 total packages, a contribution to cover packaging and handling costs of € 20 will be due.

ORDERS FOR LESS THAN 1 PALLET: for orders smaller than the full pallet, a surcharge of 1,80/m2 and 3,00/m2 for the Outdoor series will be applied.

RUSHED DELIVERIES: for rushed orders (within 24 hours), with a maximum limit of 2 total items, a fixed net surcharge of € 30 will be charged.

PACKAGING Special packaging will be charged at the cost shown in the summary table.

RETURN: The packaging of the 160x320 and 120x280 sizes can be returned and re-credited providing that it is returned in good condition.

No amount will be credited for packaging that is no longer reusable or smaller in size.

CONDITIONS GÉNÉRALES DE VENTE

1) ACCEPTATION Les commandes parvenues ne seront valables de manière définitive qu'après confirmation écrite de notre part.
2) LIVRAISON La livraison du matériel est à considérer effectuée au moment du chargement dans nos entrepôts. Tous les risques de transport, tels que les manques, les casses ,détériorations ou endommagements sont à la charge de l'Acheteur, même lorsque le prix convenu est franco , FOB ou C&F. Les accords conclus avec les transporteurs sont à considérer toujours au nom et pour compte de l'Acheteur, qui confirme et accepte le conditions au préalable.
3) DÉLAIS DE LIVRAISON Les délais de livraison ont un caractère indicatif: les éventuels retards de livraisons, interruptions, suspensions totales ou partielles des fournitures ne donneront droit à aucun dédommagement ou remboursement et intérêts.
4) RECLAMATIONS La garantie de la marchandise se limite seulement et exclusivement au matériel de premier choix, avec une marge de tolérance de 5% environ. Les différences de nuances ne pourront être dénoncées comme vice du matériel. Les éventuelles réclamations relatives à la qualité, au type de matériel, devront nous parvenir dans les 8 jours à partir du jour de livraison. L'Acheteur s'engage à mettre à disposition les parties contestées de manière à permettre le contrôle des défauts déclarés, sachant que la pose nous libère quoiqu'il en soit de toute responsabilité. Les éventuels vices ou défauts de qualité de la marchandise, si déclarés en vertu des termes de loi et confirmés ou reconnus, ne donnent droit qu'a la substitution des matériaux défectueux, à condition que les marchandises contestées ne soient rendues préalablement et, sur autorisation écrite de l'opération de restitution, en renonçant et en exluant ainsi de manière formelle la résolution du contrat tout comme les éventuels dommages et intérêts.
5) DIMENSIONS ET NUANCES Nos matériels se classent parmi les produits cuits à haute températures et peuvent présenter en tant que tels des différences entre les dimensions déclarées et celles effectivement livrées. C'est ainsi que sont considérées les différences de nuances à l'intérieur d'un même lot. C'est pourquoi, en vertu des conditions présentées précédemment, ceci ne pourra faire l'objet d'aucune réclamation de la part de l'Acheteur.
6) EMBALLAGE ET QUANTITÉS Le bon état des emballages, ainsi que de la quantité livrée est confirmé après acceptation de la marchandise de la part du transporteur. Ce dernier, en signant le Bon de Livraison, se tient responsable du bon état du matériel et de la quantité. En cas de casses ou manques, l'acheteur devra demander des éventuels dommages et intérêts ou dédommagements au transporteur.
7) RESTITUTIONS En aucun cas l'Acheteur ne pourra rendre le matériel sans préalablement recevoir une autorisation écrite de notre part et tous les frais sont à la charge de l'Acheteur.
8) ANNULLATIONS Aucune annulation de commandes ne sera acceptée si le matériel a déjà été produit ou si la phase de production a déjà été commencé, ni même si la livraison a déjà été effectuée. L'annulation de la commande comportera dans tous les cas l'obligation de la part de l'Acheteur de payer la totalité de la marchandise. Au cas ou l'acceptation de l'annulation est faisable, le Client sera formellement tenu à recouvrir tous les frais engendrés par le producteur jusqu'alors.
9) PRIX Les prix reportés sur nos catalogues ne sont pas définitifs. Nous nous réservons le droit de les modifier avant l'acceptation de la commande.
10) PAIEMENTS Les paiements ne doivent être effectués qu'après de notre siège. Le retard de plus de 10 jours de tout paiement dû ou la non couverture dans le même délai d'un titre de crédit, transféré ou cédé,ou bien émis par l'Acheteur, consitue un niveau d'insolvabilité. Dans ce cas, il est en notre pouvoir de suspendre les livraisons et annuler tout rapport en cours; d'exiger le paiement intégral et immédiat de nos crédits; d'exiger le paiement intégral de tout en notre faveur et d'agir judiciairement à cet égard, de manière exécutive ou préventive ainsi que pour les dommages et intérêts. Dans tous les cas, aussitôt qu'un paiement du dépasse le délai des 10 jours, nous sommes autorisés à émettre une traite à vue avec frais sans préavis. En outre, les intérêts moratoires annuels calculés en fonction du taux "premiers versements" courant majoré à 5 points pourcents, prendrant effet sur le débit dépassé.
11) MINIMUM UNITÉ DE VENTE Aucune vente inférieure à la boîte ne peut être effectuée.
12) DOMAINE RÉSERVÉ Le matériel, même si livré et régulièrement facturé reste notre propriété jusqu'au paiement total de ladite marchandise, même en cas de passage ou vente à un tiers.
13) TRIBUNAL COMPETENT Le Tribunal de Modena sera compétent de manière exclusive en cas de litige.

ALLGEMEINE VERKAUFSBEDINGUNGEN

1) BESTÄTIGUNG Eingegangene Bestellungen sind für uns nur verbindlich, wenn sie schriftlich durch uns bestätigt wurden.
2) LIEFERUNG Die Lieferung des Materials ist für uns mit dessen Beladung bei unserem Lager abgeschlossen. Alle durch den Transport bedingten Risiken, einschließlich Fehlmengen, Bruch, Beschädigung und sonstige Beeinträchtigungen gehen zu Lasten des Auftraggebers, auch wenn der vereinbarte Preis frachtfrei, FOB oder C&F ist. Die Vereinbarungen mit den Speditionsunternehmen werden im Namen und auf Rechnung des Auftraggebers getroffen, der die Entlastung bestätigt und erteilt.
3) LIEFERFRISTEN Die Lieferfristen sind ungefähre Angaben; im Falle einer Verzögerung, Unterbrechung bzw. teilweiser oder kompletter Aussetzung der Lieferungen besteht kein Recht auf Entschädigung oder Schadenersatz.
4) BEANSTANDUNGEN Die Garantie auf die Ware bezieht sich ausschließlich auf Material erster Wahl, bei einer Toleranz von ca. 5%. Unterschiede bei Farbönen können nicht als Materialfehler geltend gemacht werden. Eventuelle Beanstandungen in Bezug auf die Qualität und Materialart müssen innerhalb von 8 Tagen ab dem Lieferdatum bei uns eingehen. Der Käufer verpflichtet sich, die beanstandeten Warenpartien für die Überprüfung der angezeigten Mängel zur Verfügung zu halten. Die Verlegung des Materials befreit uns in jedem Fall von jeglicher Haftung. Eventuelle Fehler oder Qualitätsmängel der Ware, sofern diese innerhalb der gesetzlich vorgeschriebenen Fristen gemeldet, überprüft und anerkannt wurden, beinhalten lediglich das Recht auf einen Umtausch der fehlerhaften Materialien, unter der Bedingung, dass die beanstandete Ware vorher, nach schriftlicher Genehmigung der Warenrückgabe, zurückgeschickt wurde und unter Verzicht und Ausschluss des Anspruchs auf eine Vertragsauflösung oder jegliche Art von Schadenersatz.
5) ABMESSUNGEN UND FARBTÖNE Unsere Materialien sind als Produkte klassifiziert, die bei hohen Temperaturen gebrant werden, weshalb es sein kann, dass die tatsächlichen Abmessungen von den genannten Abmessungen abweichen. Das gleiche gilt für Farbunterschiede innerhalb desselben Warenpostens. Diese Umstände geben dem Auftraggeber kein Recht zu Beanstandungen.
6) VERPACKUNG UND MENGE Mit Annahme der Ware durch das Beförderungsunternehmen gelten der gute Zustand der Verpackungen sowie die übergebene Warenmenge als bestätigt. Das Transportunternehmen übernimmt mit Unterzeichnung des Versandscheins die Verantwortung für den guten Zustand und die Menge des Materials. Der Käufer muss sich im Fall von Brüchen oder Fehlware für eventuelle Schäden oder Entschädigungen as das Beförderungsunternehmen wenden.
7) WARENRÜCKGABE Der Käufer kann die Ware in keinem Fall ohne unsere ausdrückliche schriftliche Genehmigung zurückgeben; alle entstehenden Kosten werden vom Auftraggeber übernommen.
8) STORNIERUNGEN Auftragsstornierungen werden nicht akzeptiert, wenn das Material bereits hergestellt wurde, die Produktion angelaufen ist oder die Ware gar bereits verschickt wurde. Bei der Stornierung einer Bestellung ist der Auftraggeber in jedem Fall verpflichtet, die gesamte Lieferung zu bezahlen. Falls die Stornierung akzeptiert wird, ist der Kunde verpflichtet, alle Kosten zu übernehmen, die dem Hersteller bis zu diesem Zeitpunkt entstanden sind.
9) PREISE - Die in unserer Preisliste angegebenen Preise sind für uns nicht verbindlich. Wir behalten uns das Recht vor, diese vor de Bestellsungsannahme zu ändern.
10) ZAHLUNG - Die Zahlungen können nur direkt an uns erfolgen. Eine Verspätung von mehr als 10 tagen jeder geschuldeten Zahlung bzw. die fehlende Deckung eines girierten, abgetretenen oder vom Auftraggeber ausgestellten Kreditpapiers innerhalb desselben Zeitraums wird als Zahlunsunfähigkeit gewertet. In diesem Fall haben wir das Recht, die Lieferungen auszusetzen und jedes bestehende Geschäftsverhältnis abzubrechen; unverzüglich die vollständige Zahlung aller unserer Forderungen im Rahmen eines Vollstreckungs- oder Sicherstellungsverfahrens rechtlich zu beanspruchen, ebenso wie eine Entschädigung; in jedem fall sind wir 10 Tage nach Ablauf der Zahlungsfrist berechtigt, ohne Vorankündigung eine Sichttratte zusätzlich der entsprechenden Kosten auszustellen. Außerdem werden auf den geschuldeten Betrag die jährlichen Verzugszinsen in Höhe des laufenden, um fünf Prozentpunkte erhöhten Privatdiskontsatzes berechnet.
11) VERPACKUNGSGRÖSSE Es werden keine Mengen unterhalb der Größe eines Kartons verkauft.
12) EIGENTUMSVORBEHALT Das Material bleibt auch bei regulärem Transport und normaler Rechnungsstellung bis zur vollständigen Bezahlung der Lieferung in unserem Eigentum, auch im Falle der Weitergabe oder des Verkaufs an Dritte.
13) GERICHTSSTAND Gerichtsstand in Streitfällen ist ausschließlich das Gericht Modena.

SERVICES DE LOGISTIQUE

ANNULLATION DES COMMANDES: pour l'annulation autorisée de commandes de matériaux déjà livrés à notre entrepôt, et pour les retours autorisés, 15 % de la valeur impossible seront facturés, avec une contribution minimale fixe de 50 € pour les frais de transport et de resélection.

COMMANDES DE PETITES QUANTITÉS: pour les commandes de fonds, marches ou plinthes inférieures à 5 colis au total, une contribution aux frais d'emballage et de manutention de 20 € sera exigée.

PRODUIT DÉPALETTISÉ: un supplément de 1,80 /m² et de 3,00 /m² pour la série Outdoor sera appliqué aux commandes inférieures à la palette complète.

LIVRAISONS URGENTES: pour la préparation des commandes dans les 24 heures, avec une limite maximale de 2 articles au total, un supplément fixe net de 30 € sera facturé.

EMBALLAGES

FACTURATION: les emballages spéciaux seront facturés au tarif indiqué dans le tableau récapitulatif.

RETOUR: les emballages des formats 160x320 et 120x280 pourront être retournés et crédités à nouveau à condition qu'ils soient en bon état.

Aucun remboursement ne sera accordé pour les emballages de plus petite taille ou pour ceux qui ne sont plus réutilisables.

RETOUR: les emballages des formats 160x320 et 120x280 pourront être retournés et crédités à nouveau à condition qu'ils soient en bon état.

Aucun remboursement ne sera accordé pour les emballages de plus petite taille ou pour ceux qui ne sont plus réutilisables.

LOGISTIK-DIENSTLEISTUNGEN

STORNIERUNG VON BESTELLUNGEN: Für die genehmigte Stornierung von Bestellungen von Waren, die bereits an unser Lager geliefert wurden, und für genehmigte Rücksendungen werden 15 % des steuerpflichtigen Wertes mit einem festen Mindestbetrag von 50 als Unkostenbeitrag für Transport und Neuauswahl berechnet.

BESTELLUNG KLEINER MENGEN: Bei Bestellungen von Grundfliesen, Stufen oder Sockelleisten unter 5 Packstücken wird ein Unkostenbeitrag für Verpackung und Beförderung von 20 erhoben.

ENTPALLETIERT: Bei Bestellmengen von weniger als einer ganzen Palette wird ein Zuschlag von 1,80 /m2 und 3,00 /m2 für die ganze Serie Outdoor berechnet.

EILLIEFERUNGEN: Für die Bearbeitung von Bestellungen innerhalb von 24 Stunden und maximal 2 Artikel wird ein pauschaler Aufschlag von 30 netto berechnet.

VERPACKUNGEN

VERPACKUNGSGEBÜHR: Die Kosten für Sonderverpackungen werden gemäß der zusammenfassenden Tabelle berechnet.

RÜCKGABE: Eine Rückgabe und Gutschrift von Verpackungen der Formate 160x320 und 120x280 ist möglich, sofern sie in einem guten Zustand sind.

Für Verpackungen, die nicht wiederverwendbar oder auf kleinere Formate rückföhrbar sind, wird nichts anerkannt.

About us

Style	STONE
Group	La Geoteca
Technology	Pietra Viva
6mm	Origini
Collections	Fusion
	Burlington Stone
	Concept Stone
	Antiqua
	Soul
	Suisse

Interiors

MARBLE	RESIN
La Marmoteca	I Pigmenti
STONE	METAL
La Geoteca	Oxide
Pietra Viva	
Origini	
Concept Stone	
Burlington Stone	

RESIN	CONCRETE
I Pigmenti	Make
	Native
	Mesh Up

SOLID COLORS	WOOD
Chrome	Just Code
METAL	Timber
Oxide	Woodland

CONCRETE	WOOD
Make	Just Code
	Just Nature
	Just Color

Decor

Boiserie	I
Gioia	N
	I
	N
	I
	N

	I
	N
	I
	N
	I
	N

Technical Info

Technical info	I
	N
	I
	N
	I
	N

	I
	N
	I
	N
	I
	N

GUIDA ALLA CONSULTAZIONE CONSULTATION GUIDE

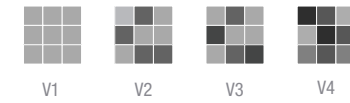

CON QUESTO TERMINE SI VUOLE INDICARE IL GRADO (V1, V2, V3, V4) DI VARIAZIONE CROMATICA FRA PIASTRELLA E PIASTRELLA RACCHIUSO IN OGNI SCATOLA DI PRODOTTO MARCHIATO.

This symbol (V1, V2, V3, V4) classifies the chromatic shade variation among pieces of tile in one box of the collection.

Mit den Abkürzungen (V1, V2, V3, V4) will man den Farbabweichungsgrad unter den Fliesen jeden Kartons von der Kollektion weisen.



Via Crociale, 69
41042 Fiorano MO (Italy)
T +39 0536 849611
www.gardenia.it - info@gardenia.it

cod. CATGEN25

MKTG 2501

Abk Group si riserva di apportare, qualora lo ritenesse opportuno, eventuali modifiche di natura tecnica o formale ai dati riportati in questo strumento. I colori sono puramente indicativi.
Abk Group reserves the right, when it deems necessary, to make technical and formal changes to the data included herein. The colours are purely illustrative



About us

Style
Group
Technology
6mm
Collections

Interiors

MARBLE

La Marmoteca

STONE

La Geoteca
Pietra Viva
Origini
Concept Stone
Burlington Stone

RESIN

I Pigmenti

SOLID COLORS

Chrome

METAL

Oxide

CONCRETE

Make

WOOD

Just Code
Just Nature
Just Color

Decor

Boiserie
Gioia

Technical Info

Technical info

Outdoor

STONE

La Geoteca
Pietra Viva
Origini
Fusion
Burlington Stone
Concept Stone
Antiqua
Soul
Suisse

RESIN

I Pigmenti

METAL

Oxide

CONCRETE

Make
Native
Mesh Up

WOOD

Just Code
Timber
Woodland

INDEX

